



# GigaVUE-HCT Hardware Installation Guide

**GigaVUE HC Series**

Product Version: 6.9

Document Version: 1.0

(See Change Notes for document updates.)

**Copyright 2024 Gigamon Inc. All rights reserved.**

Information in this document is subject to change without notice. The software described in this document is furnished under a license agreement or nondisclosure agreement. No part of this publication may be reproduced, transcribed, translated into any language, stored in a retrieval system, or transmitted in any form or any means without the written permission of Gigamon Inc.

**Trademark Attributions**

Gigamon and the Gigamon logo are trademarks of Gigamon in the United States and/or other countries. Gigamon trademarks can be found at [www.gigamon.com/legal-trademarks](http://www.gigamon.com/legal-trademarks). All other trademarks are the trademarks of their respective owners.

Gigamon Inc.  
3300 Olcott Street  
Santa Clara, CA 95054  
408.831.4000

# Change Notes

When a document is updated, the document version number on the cover page will indicate a new version and will provide a link to this Change Notes table, which will describe the updates.

Product Version	Document Version	Date Updated	Change Notes
6.9	1.0	12/06/2024	The original release of this document with 6.9 GA.

# Contents

<b>GigaVUE-HCT Hardware Installation Guide</b> .....	<b>1</b>
Change Notes .....	3
Contents .....	4
<b>GigaVUE-HCT Overview</b> .....	<b>8</b>
<b>Introducing the GigaVUE-HCT Chassis</b> .....	<b>8</b>
Hardware Root of Trust (HROt) .....	10
Dual BIOS Image .....	10
Chassis Cooling .....	11
Air Flow Direction .....	13
AC-Powered GigaVUE-HCT .....	14
Breakout Panels .....	14
<b>GigaVUE-HCT Base Chassis</b> .....	<b>14</b>
Port Numbering .....	14
System LED .....	15
PSU LED .....	15
Fan Status LED .....	16
Management Port LED .....	16
Base Chassis Port Status LEDs .....	16
<b>GigaVUE-HCT Modules</b> .....	<b>16</b>
Bypass Combo Modules .....	17
BPS-HC1-D25A24 SX/SR Bypass Combo Module .....	17
Features of the 1Gb/10Gb Bypass Combo Module .....	18
Inline Network Ports .....	18
BPS-HC1-D25A60 SX/SR Bypass Combo Module .....	19
BPS-HC1-D35C60 LX/LR Bypass Combo Module .....	19
Features of the 1Gb/10Gb Bypass Combo Module .....	20
Inline Network Ports .....	20
Bypass Combo Modules .....	20
Module Status LEDs .....	21
Port Status LED .....	21
PRT-HC1-X12 Module .....	21
Features .....	22
Module LED .....	22
Port Status LED .....	22

Rules and Notes .....	23
PRT-HC1-Q04X08 Module .....	23
Features .....	24
Module LED .....	24
Port Status LED .....	24
SMT-HC1-S (Generation 3 GigaSMART Card) .....	25
Ports & LED .....	25
TAP-HC1-G10040 Module .....	26
Using the TAP-HC1-G10040 Module for Copper Bypass .....	27
<b>Upgrading PLDs .....</b>	<b>27</b>
<b>GigaVUE-HCT Installation Roadmap .....</b>	<b>27</b>
First Steps – Getting Unpacked, Racked, Installed and Connected .....	28
Next Steps .....	29
<b>Assembling the GigaVUE-HCT Node .....</b>	<b>29</b>
Unpacking the GigaVUE-HCT Shipment .....	29
<b>Rack-Mounting the GigaVUE-HCT Chassis .....</b>	<b>30</b>
Safety Precautions .....	30
GigaVUE-HCT Chassis Assembly .....	30
Single GigaVUE-HCT Mounting Assembly .....	31
Dual GigaVUE-HCT Mounting Assembly .....	32
Rack-Mounting on GigaVUE-HCT .....	34
Four-Post Rack Mounting .....	35
<b>Installing and Removing Modules Procedure .....</b>	<b>36</b>
Hot Swapping Modules .....	36
Module Installation Procedure .....	36
<b>Module Removal and Replacement Procedure (Hot Removal) .....</b>	<b>37</b>
Replacing a Module with the Same Type of Module .....	37
Replacing a Module with a Different Type of Module .....	38
Fan Replacement Procedure .....	38
Next Steps .....	38
<b>Basic GigaVUE HC Series Connections and Configuration</b>	<b>38</b>
Connecting Power to the GigaVUE-HCT .....	39
Remove or Replace the Power Adapter .....	40
<b>Connecting Serial Console and Mgmt Ports .....</b>	<b>40</b>
<b>Configuring Basic GigaVUE® HC series Settings .....</b>	<b>41</b>
Access the Command-Line Interface over the Console Port .....	41
<b>Run the Jump-Start Script .....</b>	<b>42</b>
Need to Change Any Settings? .....	44

Configure Modules and Enable Ports .....	45
Command-Line Basics .....	46
Command-Line Modes .....	46
Differences in Commands for admin and default Level Users .....	47
Entering Commands in the CLI .....	49
Command-Line Syntax – Entering Commands .....	50
Configure Mode Syntax .....	50
Paging through CLI Output .....	51
<b>Command-Line Syntax – Entering Commands .....</b>	<b>52</b>
Configure Mode Syntax .....	53
Paging through CLI Output .....	53
<b>The Basic Commands .....</b>	<b>54</b>
<b>Completing the Initial GigaVUE® HC series Setup .....</b>	<b>58</b>
<b>Enter the Configure Command-Line Mode .....</b>	<b>58</b>
<b>SSH .....</b>	<b>59</b>
Advantages of SSH2 .....	59
Verifying Host Keys During Connection .....	59
Changing Host Keys .....	60
Connecting to the GigaVUE HC Series Node from GigaVUE-FM .....	60
Next Steps? .....	61
Configuring GigaVUE® HC series Time Options .....	61
Setting Time Manually .....	62
Performing One-Time NTP Server Synchronization .....	62
Using NTP Time Server for Clock Synchronization .....	62
Configuring Automatic Email Notifications .....	63
Using a Custom Banner .....	65
Saving Changes .....	65
<b>Connecting GigaVUE-HCT Ports .....</b>	<b>66</b>
Transceiver—Rules and Notes .....	66
Transceiver Installation Instructions .....	67
Installing Transceivers .....	67
Removing Transceivers .....	67
<b>Copper TAP Specifications .....</b>	<b>68</b>
<b>Bypass Module Specifications .....</b>	<b>68</b>
<b>Connecting GigaVUE-HCT Module Ports .....</b>	<b>69</b>
Enabling Modules and Ports .....	69
Setting Port Parameters Manually .....	71
Forcelinkup and Enabling/Disabling Ports .....	72
<b>GigaVUE-HCT Specifications .....</b>	<b>72</b>
Physical Dimensions and Weight .....	73

Battery Caution .....	73
Compliance .....	73
Safety .....	74
Emissions .....	74
Immunity .....	74
Environmental .....	74
Security .....	74
Power Requirements .....	74
Environmental Specifications .....	75
Standards and Protocols .....	75
Warranty .....	75
<b>Console Port Signaling and Cabling .....</b>	<b>75</b>
<b>Additional Sources of Information .....</b>	<b>77</b>
<b>Documentation .....</b>	<b>77</b>
How to Download Software and Release Notes from My Gigamon .....	80
<b>Documentation Feedback .....</b>	<b>80</b>
<b>Contact Technical Support .....</b>	<b>81</b>
<b>Contact Sales .....</b>	<b>82</b>
<b>Premium Support .....</b>	<b>82</b>
<b>The VUE Community .....</b>	<b>82</b>

# GigaVUE-HCT Overview

The GigaVUE-HCT is a GigaVUE HC Series Deep Observability Pipeline node with a modular 1RU design and half rack width system. The base system supports 2 x 100Gb/40Gb connectivity.

## GigaVUE-HCT

- 1RU and half rack width system
- One Module Slot (Bay) and one Fixed Base Module
- 2x100Gb/40Gb connectivity
- Supports Flex Inline in unprotected ports with 100Gb/40Gb/4x10Gb/4x25Gb speed Nodes.
- Cluster with GigaVUE HC Series and GigaVUE TA Series.
- All ports, excluding BPS ports, of the same type and speed can be used to create GigaStream.

## GigaVUE-HCT

Front View



Rear View



## Introducing the GigaVUE-HCT Chassis

The fully-assembled GigaVUE-HCT chassis consists of a 1RU, rack-mountable chassis with management, network, and tool ports at the front and power connections and fans at the rear. [Figure 1 Front View of GigaVUE-HCT Chassis](#) summarizes the bay and components at the front, and [Figure 2 Rear View of GigaVUE-HCT Chassis](#) summarizes the rear of the GigaVUE-HCT chassis.

**NOTE:** The CLI recognizes the MGMT 1 port as eth0, the MGMT 2 port as eth2, and the MGMT 3 port as eth1.

**Figure 1** Front View of GigaVUE-HCT Chassis



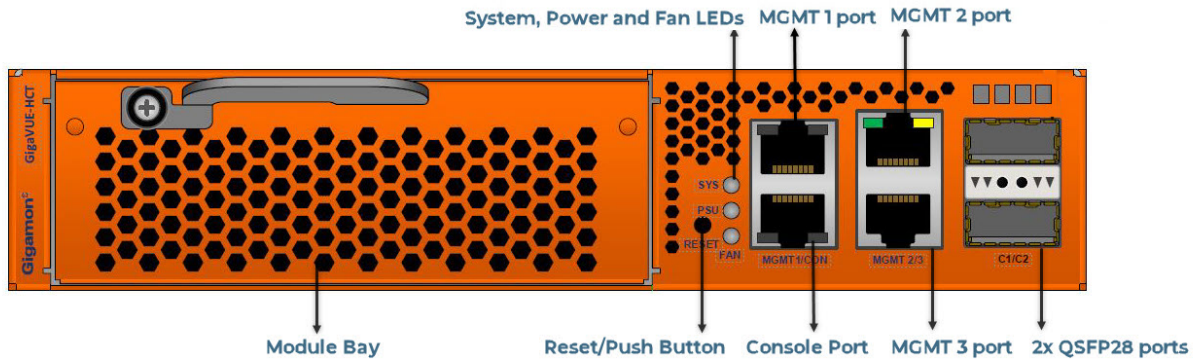

**Figure 2** Rear View of GigaVUE-HCT Chassis

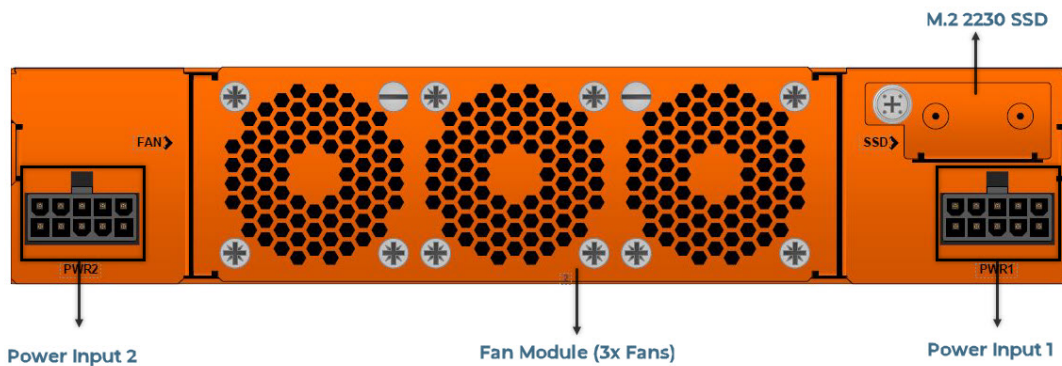

**NOTE:** The GigaVUE-HCT chassis and parts kit are shipped in one box from the factory. The chassis ships with fans installed. The parts kit contains the power cords, console cable, and power adapters. The GigaVUE-HCT modules are shipped separately. Refer to [Unpacking the GigaVUE-HCT Shipment](#) for assembly instructions.

Table 1: GigaVUE-HCT Chassis Components

Front Components on the GigaVUE-HCT Chassis	
Module Bays	The base chassis is on the right. Slot (bay) is on the left.
Base Chassis	The GigaVUE-HCT includes a base chassis that holds the management and processing components installed inside the unit. It is located to the right of the front of the chassis.

	<p><b>NOTE:</b> The base chassis is not hot-swappable.</p> <p>The base chassis also controls the Mgmt port and console port on the front of the node for network and local administrative access to the GigaVUE-OS command-line interface (CLI). The base chassis provides two QSFP28 ports, each of which can support 40Gb/100Gb or, in breakout mode, 4x10Gb/4x25Gb. The default port speed is 40Gb/100Gb which is denoted by C.</p> <p>Refer to <a href="#">GigaVUE-HCT Base Chassis</a> for more information.</p>
Management Ports	The MGMT and MGMT 3 ports support remote connections to the GigaVUE-OS using SSH. MGMT 2 port is used by the GigaSMART module (SMT-HC1-S) to access the external network for downloading certificates.
Console Ports	Initial configuration is performed in the CLI over the serial RJ45 Console port. Serial Console port accepts terminal connections to configure GigaVUE-HCT settings, including time, network, and SNMP settings.
Reset /Push Button	Use the reset/ push button to reset the device. It must be pressed continuously for five seconds.
<b>Rear Components on the GigaVUE-HCT Chassis</b>	
Power Adapter	The GigaVUE-HCT parts kit contains one power adapter. The power adapter has a 300-watt 12-volt DC rating.
	Refer to <a href="#">Power Requirements</a> for information on the power characteristics of the GigaVUE-HCT.
Power Inputs	The GigaVUE-HCT has two power inputs at the rear end of the chassis to provide 1+1 system redundancy. Each power input is used to connect 12V DC input power from the power adapter.
Fan Module	The fan module installed at the rear of the node provides system cooling. The Fan module is not hot-swappable.

## Hardware Root of Trust (HROt)

The Hardware Root of Trust is intended to establish the root of trust in the system through a secure micro-controller highly resistant to attacks. It provides the most robust form of IP security, with multiple levels of crucial verification during power-on.

To configure the HROt solution. Refer to the GigaVUE-OS CLI Reference Guide.

## Dual BIOS Image

The GigaVUE-HCT has a dual Basic Input/Output System (BIOS). The BIOS image is packaged with the software image, starting in software version 6.5. The BIOS contents are stored in flash memory, allowing the BIOS to be upgraded. There are two flash components,

a primary and a secondary.

The following CLI command displays the two flash components and indicates the BIOS image from which the system booted using asterisks:

```
(config) show version
...
1st flash version : HCT.46.002m.0 **
2nd flash version : HCT.46.002m.0
SW BIOS version  : HCT.46.003p.0
...
```

If there is a component failure in the primary flash, the GigaVUE-HCT boots from a backup golden BIOS image in the secondary flash. An SNMP trap can be configured to be sent when the system has booted from the secondary flash. The trap may indicate that the primary flash component needs to be serviced. The trap is as follows:

#### **2ndflashboot: Secondary flash boot notification**

If a BIOS upgrade is needed for enhancements in future releases, the BIOS can be manually upgraded from the CLI using the coreboot install command.

## Chassis Cooling

The fans on the GigaVUE-HCT run at 100% of their maximum speed on power-up, then drop to approximately 40% during normal operations. The fans are deployed in 2+1 redundancy mode, meaning that a single fan can fail, and immediately, the remaining fans will run at full speed to help the chassis maintain the appropriate cooling temperature at 40°C ambient. They are not hot-swappable.

**NOTE:** Avoid hot-plugging/unplugging the FAN tray in the live GigaVUE-HCT chassis.

The temperatures of five components: inlet, Host CPU, switch ASIC, optics, and GigaSMART (If SMT-HCI-S module is installed and operational) are monitored. An SNMP trap is sent when a component reaches the threshold for warning, alert, or critical temperature conditions. Refer to the following table for the temperatures at which the warning, alert, and critical traps are sent.

Table 2: Component Temperature Thresholds and Actions

Inlet Temperature	Host CPU Temperature	Switch ASIC Temperature	Optics Temperature	GigaSMART Temperature (If SMT-HCI-S module is installed and operational)
50°C Warning trap sent	85°C Warning trap sent	100°C Warning trap sent	70°C Warning trap sent	90°C Warning trap sent
55°C Alert trap sent	90°C Alert trap sent	105°C Alert trap sent	75°C Alert trap sent	95°C Alert trap sent
60°C Critical trap sent	95°C Critical trap sent	110°C Critical trap sent	80°C Critical trap sent	100°C Critical trap sent

The output of the following GigaVUE-OS CLI command displays the current intake, exhaust, CPU, switch, and optics temperatures. The output of the following GigaVUE-OS CLI command displays the fan speed in RPM (the normal operational speed is approximately 11000 RPM; the maximum speed is approximately 25500 RPM):

```
HCT (config) # show environment
*** Box 1 (GVS-HCT01) ***
-----
Power Module 1 :
Status                : on
-----
Power Module 2 :
Status                : off
-----
Fan tray 1 :
1st fan               : 15603 RPM
2nd fan               : 15603 RPM
3rd fan               : 15603 RPM
-----
Card ccl (HCT-Main-Board):
Intake temperature    : 23 C
Exhaust temperature   : 26 C
Cpu temperature       : 34 C
Switch temperature    : 43 C
cpu_3.3v voltage      : 3.360V
cpu_2.5v voltage      : 2.520V
vcc_ddr_1.21v voltage : 1.210V
cpu_1.8v voltage      : 1.790V
1.2v voltage          : 1.190V
1.0v voltage          : 0.990V
vcc_fan_3.3v voltage  : 3.320V
1.8v voltage          : 1.800V
0.88v voltage         : 0.870V
1.05v voltage         : 1.050V
5.0v voltage          : 5.000V
vddcore_td3x3 voltage : 0.820V
pvccsram voltage      : 0.970V
```

```

pvccp voltage           : 0.970V
pvnn voltage           : 0.820V
fan_hotswap_vmon voltage : 0.100V
vddcore_td3x3_pwr voltage : 0.824V
hotswap_control voltage : 0.820V
-----
Card 2 (PRT-HC1-X12):
Intake temperature     : 28 C
Exhaust temperature    : 28 C
=====

GigaVUE-HCT (config) # sh environment type fan
*** Box 1 (GVS-HCT01) ***
-----
Fan tray 1 :
1st fan           : 10922 RPM
2nd fan           : 11364 RPM
3rd fan           : 11014 RPM
=====

```

The `show chassis` command gives the following:

```

HCT (config) # sh chassis
Chassis:
Box ID           : 5*
Hostname         : HCT
Config          : yes
Mode            : default
Oper Status     : up
HW Type         : GVS-HCT01-HW
Vendor          : Gigamon
Product Code    : 132-00H9
Serial Num      : U003D
HW Rev         : 1.0
SW Rev         : 6.5.00_Beta
GDP            : disable
Tag Mode       : double
Fan Tray:
Status         : on
Power Module 1:
Status        : on
Power Module 2:
Status        : on

```

## Air Flow Direction

The air flow direction is from the front of the GigaVUE HC Series chassis to the rear. The rear-mounted fans pull air from the front to the back of the chassis. For environments with hot/cold aisles, install the chassis so the intake air at the front of the chassis is cold.

## AC-Powered GigaVUE-HCT

Gigamon provides AC-powered adapters for the GigaVUE-HCT. Refer to [Connecting Power to the GigaVUE-HCT](#) for information on connecting AC power supplies.

## Breakout Panels

Breakout panels let you connect ports on a GigaVUE HC Series node to a tool or network port, or TAP for port breakout or aggregation.

Refer to *G-TAP M Series Hardware Guide* for details.

# GigaVUE-HCT Base Chassis

The base chassis HCT-C02 is the heart of the GigaVUE-HCT, providing processing and switching fabric resources, as well as user access to the CLI via the Mgmt/console ports.

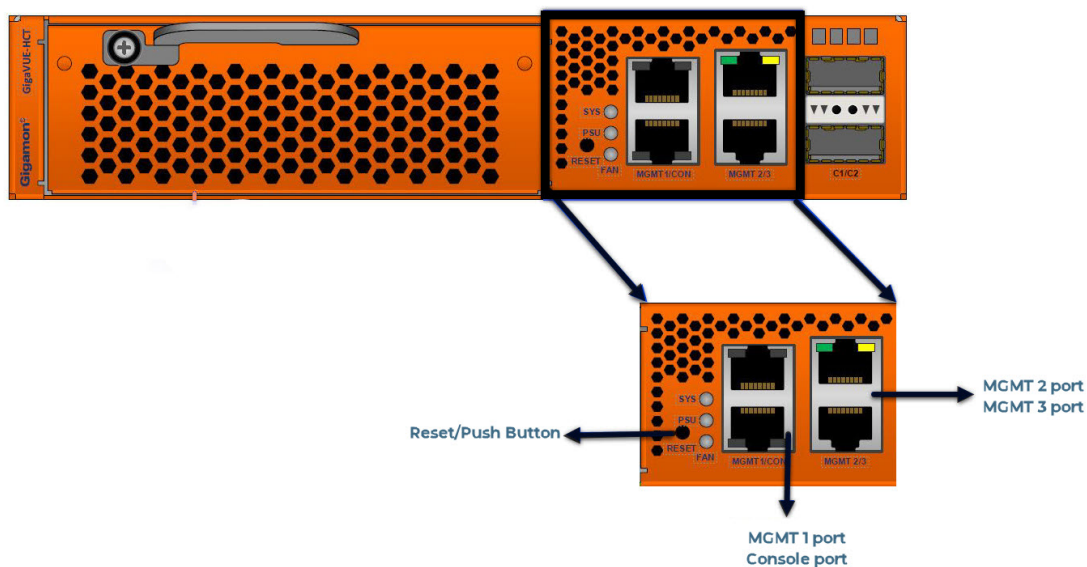

## Port Numbering

The base chassis uses standard conventions for identifying network/ tool ports, both on the modules themselves, as well as in the CLI:

### 100Gb/40Gb Ports

- Numbered with a leading **C**. For example, the base chassis includes 100Gb/40Gb ports **C1** to **C2**.

**NOTE:** When referring to ports in the CLI, the format is **box ID/slot ID/port ID**. For example, **1/1/c1** refers to box 1, slot 1, port c1.

- **GigaVUE-HCT:** The base chassis is on the right. Slot (bay) is on the left.

**NOTE:** The port labels on the base chassis faceplate use upper-case C character to identify ports. However, the CLI uses lowercase notation to refer to ports (for example, c1).

## System LED

The system LED on the front of the chassis is as follows:

- Slow blink RED indicates that HRoT MCU is in the pre-boot phase.
- Fast blink RED indicates that the HRoT MCU has loaded and started to execute the primary/golden firmware image.
- Slow blink GREEN indicates that the HRoT MCU has authenticated the BIOS image and allowed the CPU to start booting up.
- Fast blink GREEN indicates that the BIOS boot-up is complete. If the system has booted BIOS from the golden path, the SYS LED will continue to show the “Fast blink GREEN” state even after the GigaVUE-OS is up.
- Solid GREEN indicates that the system has booted completely via the primary path, the GigaVUE\_OS is UP and, the system is operating normally without alarms.
- System LED being Solid RED in conjunction with PSU and FAN LEDs being OFF indicates boot-up failure. It could also indicate a critical alarm (such as over-temperature).
- System LED being Solid RED in conjunction with PSU LED being Solid RED and FAN LED being OFF indicates that the system was powered off to protect the host CPU from over-temperature.
- System LED being Solid RED in conjunction with other combinations of PSU and FAN LED (i.e., other than the two points preceding this) indicates a power failure. The states of the LEDs should be reported to Gigamon for failure analysis.

## PSU LED

The individual power LED status on the chassis are as follows:

**NOTE:** If the SYS LED is solid red (indicative of device failure), this LED, along with the FAN LED, may be signaling additional information about the failure.

- OFF indicates that no power is being received by the PSU.
- Blinking GREEN indicates that the system has two PSUs of which one is operating normally without any warning/alarm and the other has no input voltage.
- Solid GREEN indicates normal operation.

## Fan Status LED

The Fan status LED on the front of the chassis are as follows:

**NOTE:** If the SYS LED is solid red (indicative of device failure), this LED, along with the PSU LED, may be signaling additional information about the failure.

- OFF indicates that the fans are receiving no power.
- Blinking RED indicates that one fan has failed (the system can operate with one failed fan tray but needs servicing).
- Solid RED indicates that more than one fan has failed.
- Solid GREEN indicates that normal operation is happening with all fans in a healthy state.

## Management Port LED

The Management Port LED on the front of the chassis is as follows:

- The LINK LED (Left side) status is as below:
  - Off indicates that the link is down.
  - Solid GREEN indicates that the link is up.
- The ACT LED (right side) status is as below:
  - Off indicates that there is no receive activity on the port.
  - Blinking GREEN indicates that the port is active and is transmitting or receiving packets.

## Base Chassis Port Status LEDs

The 100/40Gb port status LED has the following states:

- Off indicates the port is administratively enabled, but the link is operationally down.
- AMBER indicates the port is administratively disabled.
- GREEN indicates the link is operationally up.

## GigaVUE-HCT Modules

The GigaVUE-HCT has one bay for replaceable modules. The following modules are available for the GigaVUE-HCT:



Module	Description	Section
<b>BPS-HC1-D25A24</b>	Bypass Combo Module with two SX/SR (50/125µm multimode) inline network port pairs and four SFP and SFP+ port cages	<a href="#">BPS-HC1-D25A24 SX/SR Bypass Combo Module</a>
<b>BPS-HC1-D25A60</b>	Bypass Combo Module with six SX/SR (50/125µm multimode) inline network port pairs.	<a href="#">BPS-HC1-D25A60 SX/SR Bypass Combo Module</a>
<b>BPS-HC1-D35C60</b>	Bypass Modules with six LX/LR single-mode inline network port pairs	<a href="#">BPS-HC1-D35C60 LX/LR Bypass Combo Module</a>
<b>PRT-HC1-X12</b>	PRT-HC1-X12 provides twelve 10Gb/1Gb SFP+/SFP network, tool, hybrid, circuit, inline network, and inline tool ports. Moreover, 10Gb ports can be used as stack-link ports.	<a href="#">PRT-HC1-X12 Module</a>
<b>PRT-HC1-Q04X08 Module</b>	The PRT-HC1-Q04X08 line card module increases the port density and allows GigaVUE-HCT to connect with GigaVUE TA Series and GigaVUE HC Series nodes with higher-speed (1Gb/10Gb/25Gb/40Gb) links.	<a href="#">PRT-HC1-Q04X08 Module</a>
<b>Generation 3 GigaSMART Card (SMT-HC1-S)</b>	Generation 3 GigaSMART module, (SMT-HC1-S) gives up to 80Gb throughput.	<a href="#">SMT-HC1-S (Generation 3 GigaSMART Card)</a>
<b>TAP-HC1-G10040</b>	Copper TAP with 8 x 1Gb 1000Mb ports for either four TAPs or bypass copper (BPC) port pairs.	<a href="#">TAP-HC1-G10040 Module</a>

Modules are hot-swappable and can be installed in any available front bays in a GigaVUE-HCT node. **However, refer to [Module Removal and Replacement Procedure \(Hot Removal\)](#) for instructions – you must follow a specific procedure when removing modules to preserve node stability.**

## Bypass Combo Modules

There are three 1Gb/10Gb bypass combo modules as follows:

### BPS-HC1-D25A24 SX/SR Bypass Combo Module

Bypass Combo Module with two SX/SR (50/125µm multi-mode) inline network port pairs and four regular SFP+ port cages (BPS-HC1-D25A24) ([Figure 3 Bypass Combo Module BPS-HC1-D25A24](#))

Before installing the BPS-HC1-D25A24 Bypass Combo Module, the GigaVUE-HCT must be running software version 6.5 or higher.

For internal transceiver and loss summary specifications, refer to [Bypass Combo Module Specifications](#).

**NOTE:** The protected 1Gb link will remain down after performing a shutdown and no shutdown on the BPS-HC1-D25A24 module, as well as during module Online Insertion and Removal (OIR) on the GigaVUE-HCT chassis. Disabling and re-enabling the port will help to restore the link.

### BPS-HC1-D25A24

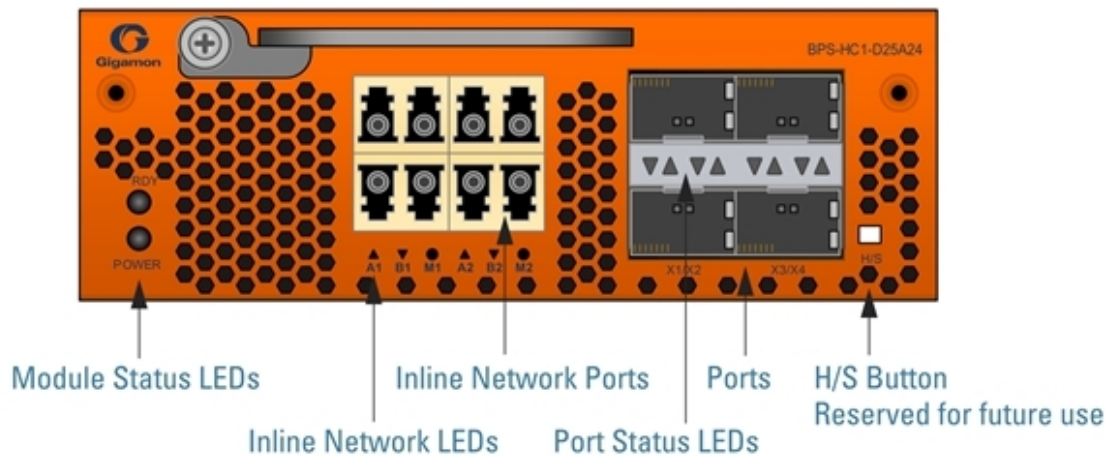

**Figure 3** Bypass Combo Module BPS-HC1-D25A24

## Features of the 1Gb/10Gb Bypass Combo Module

The 1Gb/10Gb bypass combo module has the following features:

- Two Inline network port pairs pass traffic bi-directionally.
- Port pairs that offer optical protection switches for physical bypass.
- Four regular SFP/SFP+ ports that can operate at 1Gb/10Gb, and SFP+ ports that can operate at 10Gb. These ports can be configured as any port type.
- Option to select between bypass or inline modes.
- The hot-swap button is not supported, but the command "**card slot <slot id> down**" can be used to hot-swap the module from the chassis.

## Inline Network Ports

Connect inline networks to the inline network ports. The inline network ports have built-in protection for power down.

The inline network status LEDs have the following labels:

- A1—Inline network LED A (for network 1 through network 2)
- B1—Inline network LED B (for network 1 through network 2)
- M1—Mode LED (on is inline and off is bypass)
- .

- .
- A2—Inline network LED A (for network 1 through network 2)
- B2—Inline network LED B (for network 1 through network 2)
- M2—Mode LED (on is inline and off is bypass)

**NOTE:** In the GigaVUE-OS CLI, the inline network ports are referred to as x5 to x8.

## BPS-HC1-D25A60 SX/SR Bypass Combo Module

The BPS-HC1-D25A60 is a multi-mode SR 1Gb/10Gb bypass module. Bypass Modules offer six inline network port pairs each.

Before installing the BPS-HC1-D25A60 Bypass Combo Module, the GigaVUE-HCT must be running software version 6.9 or higher.

For internal transceiver and loss summary specifications, refer to [Bypass Combo Module Specifications](#).

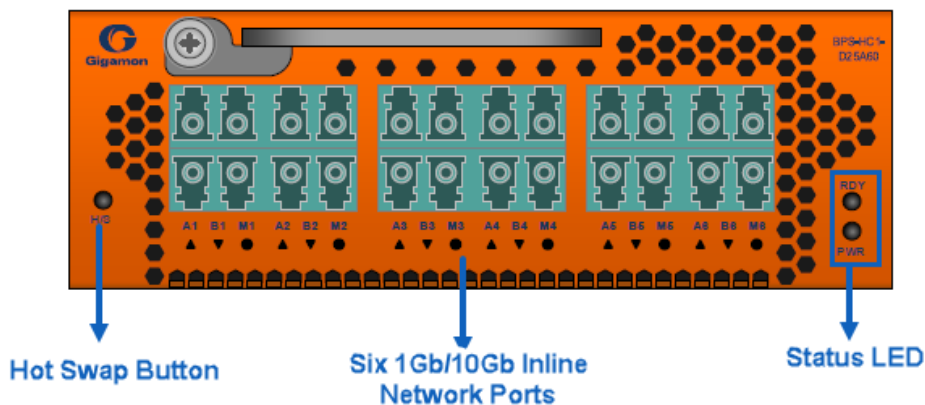

**Figure 4** Bypass Combo Module BPS-HC1-D25A60

## BPS-HC1-D35C60 LX/LR Bypass Combo Module

The BPS-HC1-D35C60 is a single-mode LR 1Gb/10Gb bypass module. Bypass Modules offer six inline network port pairs each.

Before installing the BPS-HC1-D35C60 Bypass Combo Module, the GigaVUE-HCT must be running software version 6.9 or higher.

For internal transceiver and loss summary specifications, refer to [Bypass Combo Module Specifications](#).

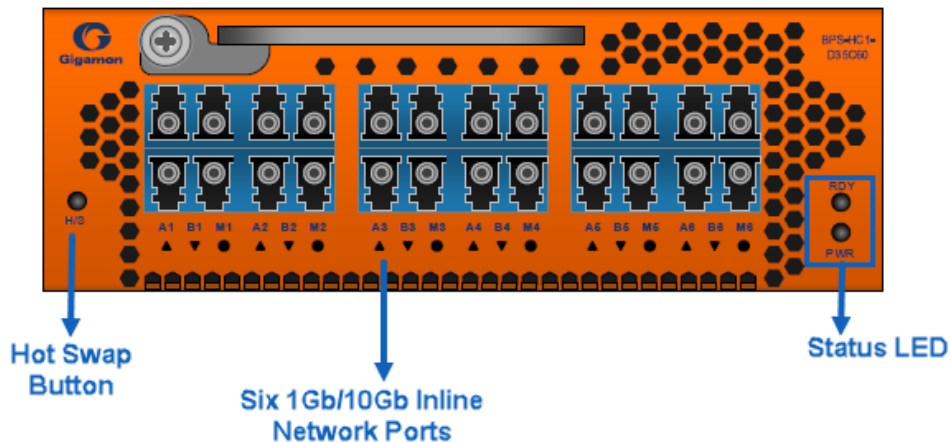

**Figure 5** Bypass Combo Module BPS-HC1-D25C60

## Features of the 1Gb/10Gb Bypass Combo Module

The 1Gb/10Gb bypass combo module has the following features:

- Inline network port pairs pass traffic bi-directionally.
- Port pairs that offer optical protection switches for physical bypass.
- The twelve SFP+ ports can operate on both 1Gb/10Gb.
- Option to select between bypass or inline modes.
- The hot-swap button is supported.

## Inline Network Ports

Connect inline networks to the inline network ports. The inline network ports have built-in protection for power down.

The inline network status LEDs have the following labels:

- A1—Inline network LED A (for network 1 through network 2)
- B1—Inline network LED B (for network 2 through network 1)
- M1—Mode LED (on is inline and off is bypass)
- .
- .
- A6—Inline network LED A (for network 1 through network 2)
- B6—Inline network LED B (for network 2 through network 1)
- M6—Mode LED (on is inline and off is bypass)

## Bypass Combo Modules

Security tools such as firewalls and intrusion detection/protection systems are often connected inline on production networks, with traffic flowing from the network segment through the tool and then back onto the production network.

The GigaVUE-HCT offers physical and logical Inline Bypass. Physical bypass provides automatic failover protection in the case of a power failure. The bypass combo modules provide the physical bypass function. As it applies to a single pair of inline network ports, the physical bypass function is as follows:

- When the module is not powered (either the entire node is powered down or the module is removed from the node), the inline network port pair is in the physical bypass mode. That means that traffic is exchanged directly between network Port A and network Port B of the inline network pair.
- When the module is powered, the mode (inline or bypass) of the inline network port pair is controlled through software. In the physical bypass mode, the inline network port pair behaves exactly as if the module was not powered. In inline mode, the inline network port pair behaves like any other inline network port pair configured to work with an inline tool.

Modules are hot-swappable. Refer to [Hot Swapping Modules](#) for instructions.

## Module Status LEDs

The following module status LEDs are located on the front of the bypass combo module:

- RDY is the Ready LED. It has the following states:
  - RED indicates system booting or module down
  - GREEN indicates normal condition
- POWER is the Power LED. It has the following state:
  - GREEN indicates the module is receiving power.

## Port Status LED

The SFP+ Port Status LED has the following states:

- Off indicates that the port is disabled or the link is down
- GREEN indicates that the link is established.

## PRT-HC1-X12 Module

The PRT-HC1-X12 line card consists of twelve(12) 1Gb/10Gb (X1 to X12) SFP/SFP+ ports. This module increases the port density and allows GigaVUE-HCT to connect with GigaVUE TA Series and GigaVUE HC Series nodes with 1G/10G links. It provides connectivity of 120Gb with line rate on-board switching across 1Gb/10Gb ports. All ports in the PRT-HC1-X12 module can be used as network, tool, hybrid, circuit, inline network, and inline tool ports. Moreover, the 10Gb ports can be used as stack-link ports.

Before installing the PRT-HC1-X12 Module, the GigaVUE-HCT must be running software version 6.9 or higher. Refer to [Figure 6 PRT-HC1-X12 Module](#).

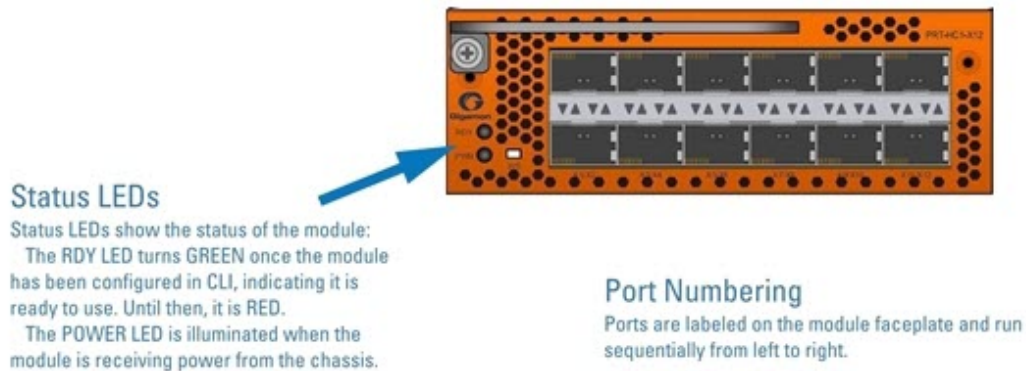

**Figure 6** PRT-HC1-X12 Module

## Features

1. This module is hot swappable.
2. The hot-swap button is not supported, but the command "**card slot <slot id> down**" can be used to hot-swap the module from the chassis.

For details about the supported transceiver, cable type, fan-out, inline ports, and clusters, refer to GigaVUE-OS Compatibility and Interoperability Matrix.

## Module LED

The LEDs on the modules indicate the current operational status. The operational states indicated by the color of Power (PWR) and Ready (RDY) LEDs are as described below.

LEDs	Color	Description
PWR - Power LED	Solid Green	Indicates the module is receiving power
RDY - Ready LED	Solid Green	Indicates normal condition
	Solid Red	Indicates system booting or module down

## Port Status LED

The 1Gb/10Gb SFP/SFP+ LED states are as described below:

LED	Color	Description
Port LED X1..X12	OFF	Port is administratively disabled, or the link is down.
	Solid Green	Link up
Activity LED	N/A	Unused

## Rules and Notes

1. In a cluster, performing chassis reload, power cycle, or PRT-HC1-X12 card shut while traffic is running may cause ports to malfunction. To resolve this issue, stop the traffic first, then reload or power cycle the chassis.
2. In a cluster, performing port shut while traffic is running may cause ports to malfunction. To resolve this issue, stop the traffic first, then toggle the malfunctioning port admin status.

## PRT-HC1-Q04X08 Module

The PRT-HC1-Q04X08 line card consists of four (4) 40Gb QSFP+ ports, four (4) 1Gb/10Gb/25Gb (X1 to X4) /SFP/SFP+/SFP28 ports and four (4) 1Gb/10Gb (X5 to X8) /SFP/SFP+ ports. This module increases the port density and allows GigaVUE-HCT to connect with GigaVUE TA Series and GigaVUE HC Series nodes with higher-speed (40Gb) links. It provides connectivity of 300Gb with line rate on-board switching across the 1Gb/10Gb/25Gb/40Gb ports. All ports in the PRT-HC1-Q04X08 module can be used as network, tool, hybrid, circuit, inline network, and inline tool ports. Moreover, the 40Gb/25Gb/10Gb ports can be used as stack-link ports.

The PRT-HC1-Q04X08 is a legacy GigaVUE-HCT line card, where the ports Q1..Q4 when inserted in GigaVUE-HCT will support 40Gb speed with the nomenclature q1..q4.

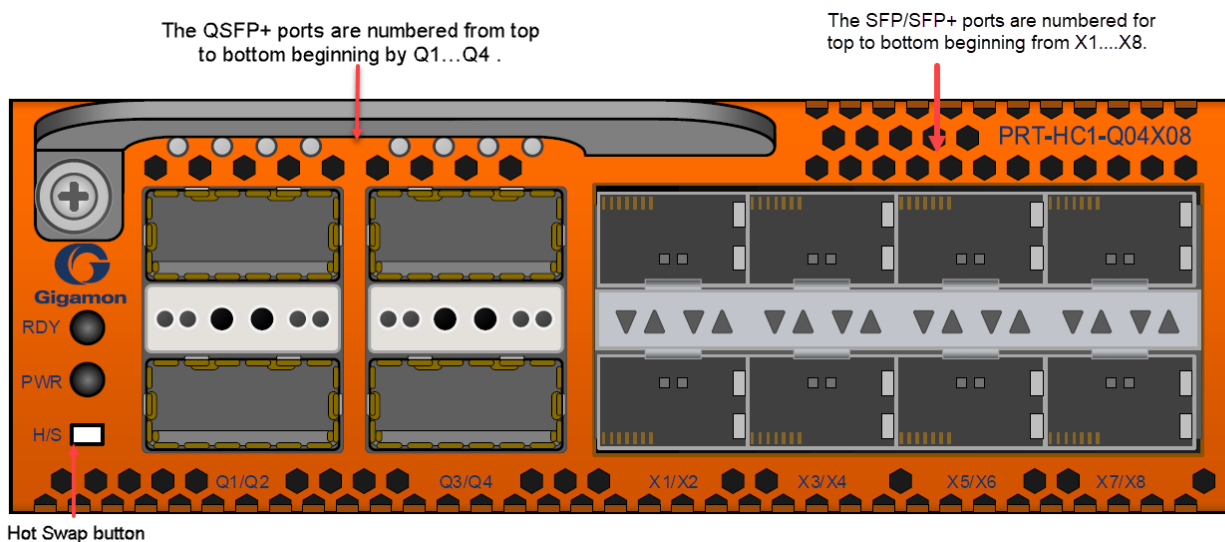

**NOTE:** when the line card PRT-HC1-Q04X08 is inserted in the GigaVUE-HCT, The ports X1..X4 will support 1Gb/10Gb/25Gb speed and the ports X5..X8 will support 1Gb/10Gb speed.

## Features

1. All ports, including breakout ports of this module, can be used as network, tool, hybrid, circuit, inline network and inline tool ports. The first group of four ports (x1..x4) can be configured as 25Gb. In one quad, there cannot be a mix of 10Gb and 25Gb ports. By default, all eight ports are configured as 10Gb ports. To configure 25Gb, you must configure the port speed as follows: (config) # port 1/2/x1..x4 params admin enable (config) # port 1/2/x1..x4 params speed 25000.
2. The ports can be used for 10Gb/40Gb, 4x10Gb, and 25Gb stacking.
3. The module supports 4x10Gb breakout on the 40Gb ports using SR4/PLR4/PSM4 optics.
4. The breakout ports can be used in clustering and supports IP interface configuration for netflow and tunneling. The ports in the line card can be added as part of GigaStream as well.
5. This module is hot swappable.

For details about the supported transceiver, cable type, fan-out, inline ports, and clusters, refer to GigaVUE-OS Compatibility and Interoperability Matrix.

## Module LED

The LEDs on the modules indicate the current operational status. The operational states indicated by the color of Power (PWR) and Ready (RDY) LEDs are as described below.

LEDs	Color	Description
PWR - Power LED	Solid Green	Indicates the module is receiving power
RDY - Ready LED	Solid Green	Indicates normal condition
	Solid Red	Indicates system booting or module down

## Port Status LED

The 40Gb Port LED Q1..Q4 and 1Gb/10Gb/25Gb SFP/SFP+/SFP28 LED states are as described below:

LED	Color	Description
LED Q1..Q4	OFF	Port is administratively disabled, or the link is down.
	Solid Green	Link up



LED	Color	Description
Port LED X1..X8	OFF	Port is administratively disabled, or the link is down.
	Solid Green	Link up
Activity LED	N/A	Unused

## SMT-HC1-S (Generation 3 GigaSMART Card)

GigaVUE-HCT supports the Generation 3 GigaSMART card (SMT-HC1-S), which gives up to 80Gb throughput. There are no front end ports on this module.

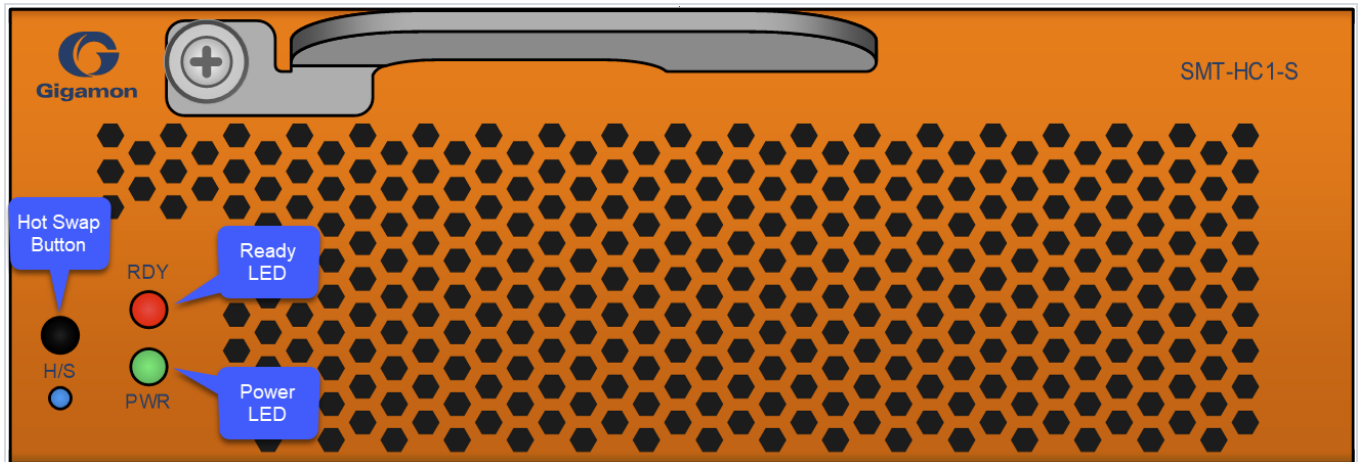

Modules are hot-swappable. Refer to [Hot Swapping Modules](#) for instructions.

### Ports & LED

Generation 3 GigaSMART Card (SMT-HC1-S)	
<b>Maximum Modules Per Chassis</b>	The maximum SMT-HC1-S number of modules per chassis is one.
<b>Power LED (PWR)</b>	<p>The LED indicates the operational status of the module as follows:</p> <ul style="list-style-type: none"> <li>• OFF means the module is not powered up.</li> <li>• GREEN means the module is powered on.</li> </ul>

Generation 3 GigaSMART Card (SMT-HCI-S)	
<b>Ready LED (RDY)</b>	The LED indicates the operational status of the module as follows: <ul style="list-style-type: none"> <li>• OFF means the module is inserted but not yet configured.</li> <li>• RED means the module failed.</li> <li>• GREEN means the module is ready.</li> </ul>
<b>H/S LED</b>	The LED indicates the operational status of the module as follows: <ul style="list-style-type: none"> <li>• OFF means the module is in normal operation.</li> <li>• BLUE means the module is ready to be removed when the card is shut down or not configured. LED turns on at insertion of module.</li> </ul>
<b>Hot Swap Button</b>	The hot-swap button is not supported, but the command " <b>card slot &lt;slot id&gt; down</b> " can be used to hot-swap the module from the chassis.

## TAP-HCI-G10040 Module

The TAP-HCI-G10040 module provides four 1000Mb/100Mb/10Mb Copper TAP connections to be used as network ports. This module has eight ports, enabling four TAPs. Each port pair is arranged with one port above the other, providing bidirectional traffic flow between two nodes. Traffic is copied through the use of a port pair, unless the port pair is in the physical bypass state. The hot-swap button is not supported. But the modules are hot-swappable. Refer to [Hot Swapping Modules](#) for instructions.

Before installing the TAP-HCI-G10040 Module, the GigaVUE-HCT must be running software version 6.5 or higher. Refer to [Figure 7 TAP-HCI-G10040 Module](#).

For details about the connectivity specifications, refer to “*GigaVUE-OS Compatibility and Interoperability Matrix*”.



**Figure 7** TAP-HCI-G10040 Module

## Using the TAP-HC1-G10040 Module for Copper Bypass

The network ports on the TAP-HC1-G10040 module can be configured through software to be inline network ports. This allows the TAP-HC1-G10040 module to act as a copper bypass module, providing protected inline networks for copper ports.

To use the copper bypass functionality, the GigaVUE-HCT must be running GigaVUE-OS version 6.5 or higher. For configuration information, refer to the chapter “Configuring Inline Bypass Solution on GigaVUE HC Series TAP Modules” in the *GigaVUE-OS CLI Reference Guide*.

## Upgrading PLDs

Use the **pld** CLI command to upgrade programmable logic devices (PLDs) on GigaVUE-HCT nodes. These devices include Complex programmable Logic Device (CPLDs). The following components have an CPLD:

- HCT-C02 module (main board)
- BPS-HC1-D25A60 module
- BPS-HC1-D35C60 module

**NOTE:** The Legacy modules PRT-HC1-Q04X08, SMT-HC1-S, PRT-HC1-X12, BPS-HC1-D25A24, and TAP-HC1-G10040 cards do not support PLD Upgrade.

CPLD images are bundled with the software image and upgraded with the software image upgrade; however, the **pld** command provides the ability to upgrade each CPLD individually. After a PLD upgrade, the node requires a power cycle.

Issue the **show pld** command to display the PLDs that need to be upgraded, then only upgrade those. Refer to the following examples for GigaVUE-HCT:

```
HCT-SW-6012 (config) # sh pld
Box ID: 2
Slot      HW Type      Cur Rev  Need Upgrade
-----
cc1      HCT-Main-Board  144      no
1        HCT-C02        144      no
2        BPS-HC1-D25A60  4        no
```

## GigaVUE-HCT Installation Roadmap

This chapter provides a flow chart of the major steps you need to perform to get a GigaVUE-HCT node unpacked, rack-mounted, installed, and connected. It also describes what you should do once you have completed the initial setup of the node. Refer to the following sections for details:

- [First Steps – Getting Unpacked, Racked, Installed and Connected](#)
- [Next Steps](#)

## First Steps – Getting Unpacked, Racked, Installed and Connected

You have received your GigaVUE-HCT node and now you are ready to get up and running. [Figure 8 Getting Started Roadmap](#) shows the major steps you need to perform to get the GigaVUE-HCT chassis out of the box, into a rack, installed with modules, plugged in, and running on your network.

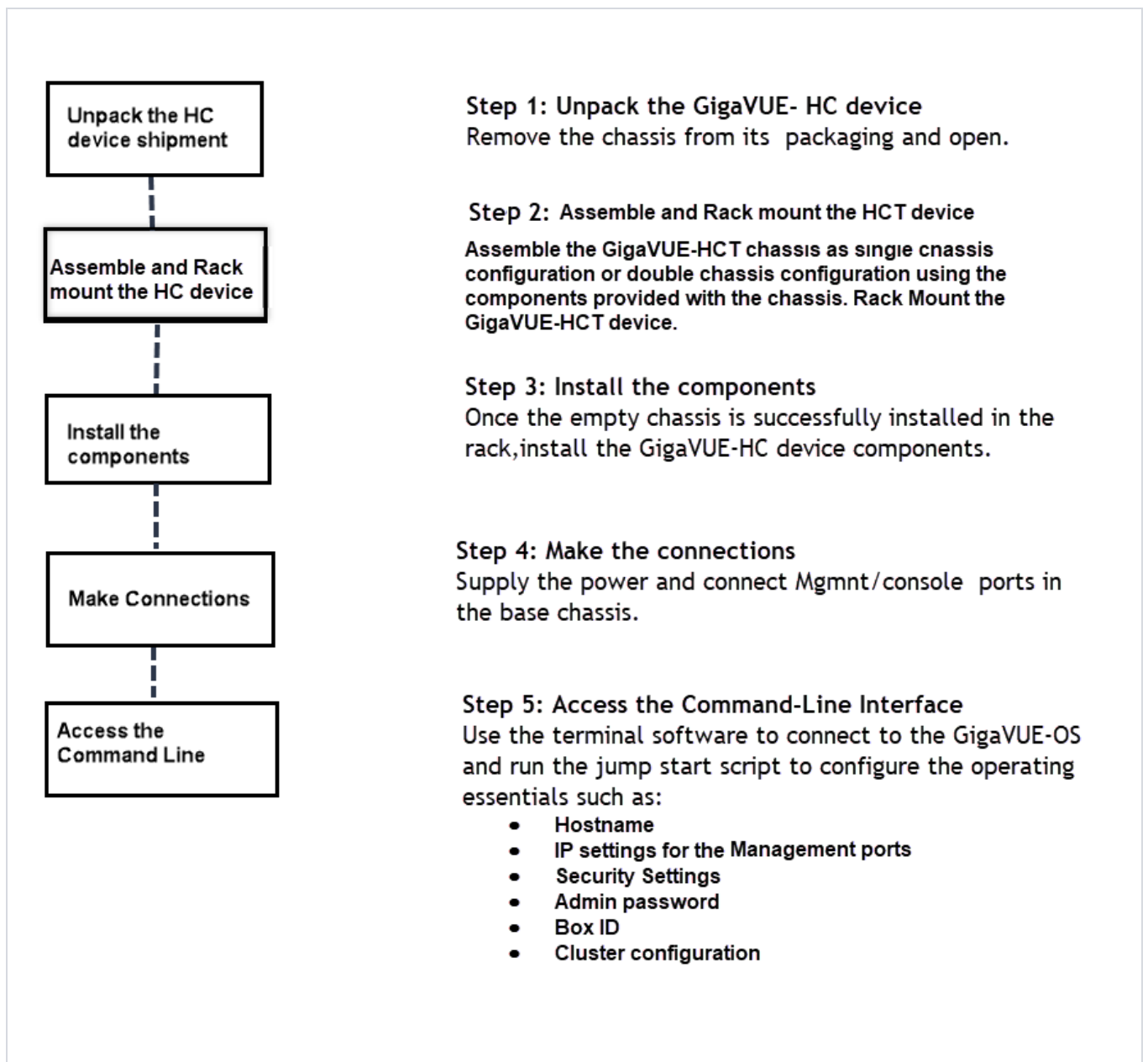

**Figure 8** Getting Started Roadmap

## Next Steps

Once you have performed the initial configuration of the GigaVUE-HCT node, installing, connecting, and configuring the node, you are ready to start mapping traffic between network and tool ports.

Refer to the *GigaVUE-OS CLI Reference Guide*, **GigaVUE Administration Guide**, and online help for information.

# Assembling the GigaVUE-HCT Node

This chapter explains how to unpack, rackmount, and assemble the GigaVUE-HCT node using the components that came with your shipment.

Separate sections are provided for unpacking and rack-mounting the GigaVUE-HCT nodes, as well as installing and removing modules. Refer to the following sections for details:

- [Unpacking the GigaVUE-HCT Shipment](#)
- [Rack-Mounting the GigaVUE-HCT Chassis](#)
- [Installing and Removing Modules Procedure](#)
- [Module Removal and Replacement Procedure \(Hot Removal\)](#)

## Unpacking the GigaVUE-HCT Shipment

The GigaVUE-HCT node is shipped with an AC power adapter, a fan, and a filler panel installed. The chassis and parts kit are shipped in one box, and modules are shipped in separate boxes. Use the following procedure to unpack the node:

1. Inspect the shipping boxes. If any cartons were damaged, file a claim with the carrier who delivered them.
2. Open the box containing the GigaVUE-HCT chassis and remove the parts kit from the top of the shipment. The parts kit contains the power cords, console cable, and power adapter.
3. Open the additional boxes containing the ordered modules and set them aside for assembly (each module is shipped in separate boxes).
4. Leave all protective filler panels in place in the chassis. **DO NOT** install the modules yet. Gigamon recommends rack-mounting the GigaVUE-HCT chassis empty.



# Rack-Mounting the GigaVUE-HCT Chassis

This section describes how to rack-mount the GigaVUE-HCT chassis in a standard 1RU rack space using the rack mount kit (RMK-HCT00). The rack mount kit (RMK-HCT00) is a separately orderable part and is not included in the GigaVUE-HCT package. You can install the GigaVUE-HCT chassis as a single unit or dual unit in two-post or four-post racks with a depth of 17 inches wide x 23.5 deep x 1.75 long.

## Safety Precautions

Before you get started rack-mounting the GigaVUE-HCT chassis, make sure you have read the following safety precautions:

- There are a wide variety of racks available on the market. Make sure you consult the instructions provided by your rack vendor for detailed mounting instructions before installing the GigaVUE-HCT chassis.
- Make sure you install any stabilizers provided for the rack before installing the chassis. Unsecured racks can tip over and cause injury or death.
- Make sure you install devices in the rack from the bottom, with the heaviest devices at the bottom.
- Make sure you provide adequate ventilation to the nodes installed in the rack.

## GigaVUE-HCT Chassis Assembly

This section describes how to assemble the GigaVUE-HCT chassis as a single or dual unit using the rack mount kit (RMK-HCT00). The rackmount kit (RMK-HCT00) comes with two short rack ears, one long rack ear, a slide bracket, a slide rail bracket, a link plate, and 20 screws.

Decide whether you want to assemble a single chassis or dual chassis in the rack. Use the following procedure to assemble the GigaVUE-HCT chassis:

## Single GigaVUE-HCT Mounting Assembly

1. Install the **short rack ear mounting bracket** on the outer side GigaVUE-HCT chassis using the four short screws, as shown in the below figure.

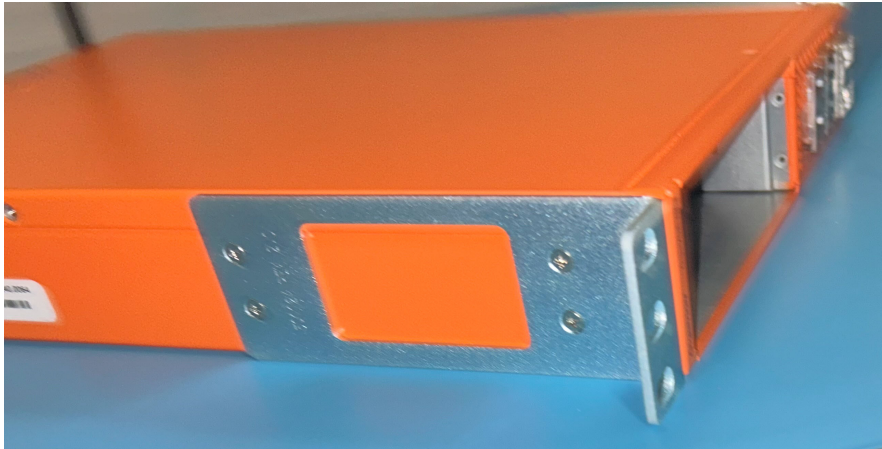

2. Install the **long rack ear mounting bracket** on the GigaVUE-HCT chassis using the four short screws, as shown in the below figure.

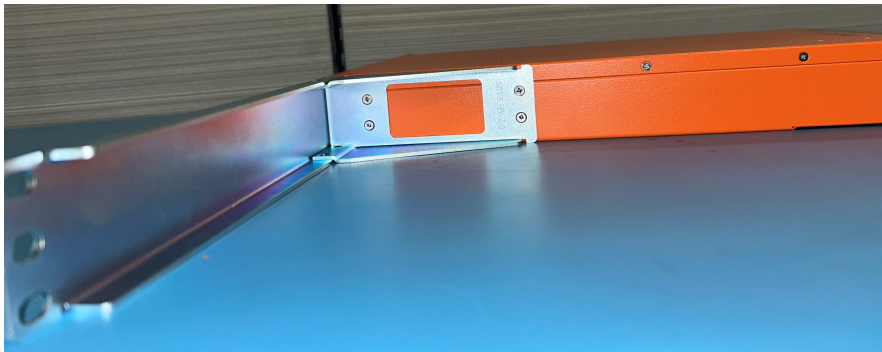

3. Mount the GigaVUE-HCT chassis in the rack. Refer [Rack-Mounting on GigaVUE-HCT](#)



## Dual GigaVUE-HCT Mounting Assembly

1. Install the **short rack ear mounting brackets** on the outer sides of the two GigaVUE-HCT chassis using the four short screws, as shown in the below figures.

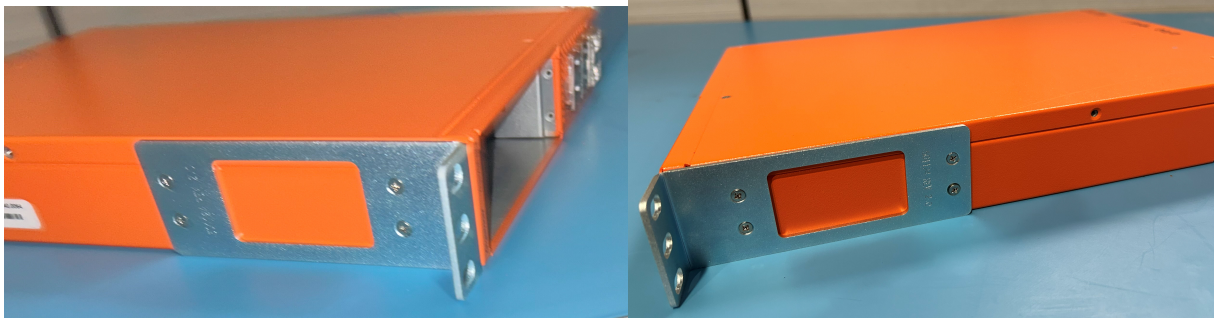

2. Install the **slide bracket** on the inner side of the first GigaVUE-HCT chassis using the four short screws, as shown in the below figure.



3. Install the **slide rail bracket** on the inner side of the second GigaVUE-HCT chassis using the four short screws, as shown in the below figure.





4. Align the **slide bracket** on the first GigaVUE-HCT chassis with the **slide rail bracket** on the second GigaVUE-HCT chassis. Slide the slide rail bracket into the slide bracket, as shown in the below figure.



5. Flip the two units and Install the **link plate** on the chassis bottom that connects the two GigaVUE-HCT chassis using the four short screws, as shown in the below figure.

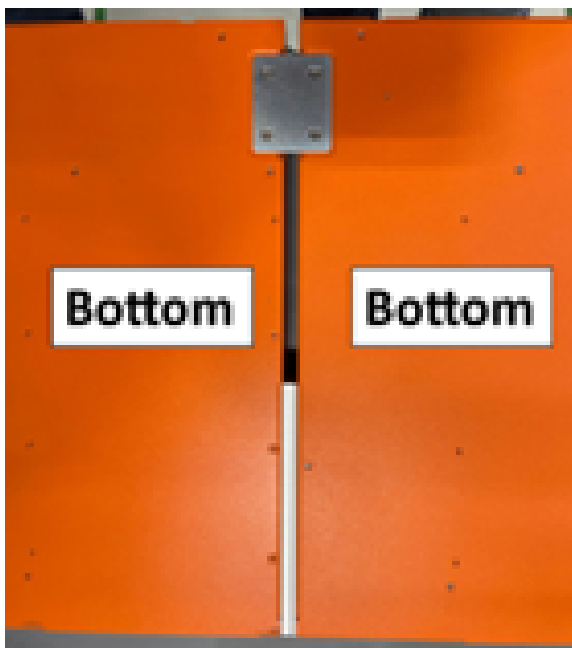

6. Mount the chassis pair in the rack. Refer [Rack-Mounting on GigaVUE-HCT](#)



## Rack-Mounting on GigaVUE-HCT

Once the GigaVUE-HCT chassis is assembled with the brackets. Use the following procedure to rackmount the GigaVUE-HCT chassis:

1. **Decide whether you want to front-mount or center-mount the chassis in the rack.** Front-mounted nodes will sit flush with the front of the rack while center-mounted nodes will extend in front of it.

**NOTE:** The GigaVUE-HCT chassis is not shipped with its standard rack ears attached. However, they are available in the accessory kit. Install the rack ears facing towards the node for a front-mounting position. You can reverse the direction of the rack-ears to center-mount the node.



Rack ears face towards the front of the node for Front mounting

Double Chassis Assembly

**Figure 9** Rack Ears for Front Mount (Reverse Rack Ears for Center Mount)

2. Make sure you have not installed any modules in the chassis yet. Gigamon recommends rack-mounting the GigaVUE-HCT chassis before installing modules to make it easier to handle the chassis during the installation.
3. Select a suitable location for the rack that will hold the GigaVUE-HCT chassis. Choose a location that is clean, dust free, and well-ventilated. You will need access to grounded power sources. Avoid areas where heat, electrical wire, and electromagnetic fields are generated.

Plan for enough clearance in front of a rack so you can access the modules easily (approximately 25in [63.50cm]) and enough clearance in the back of the rack to allow sufficient airflow and installation of the rear components such as power supply modules.

4. Locate an open 1RU rack space and lift the node into place. It takes two people to lift and place the GigaVUE-HCT in the rack. Insert a screw through the rack ear on each side into the rack, to hold the node in place. Tighten the screws.
5. Carefully lift the chassis into the rack and place a screw on each side to hold the chassis.
6. Tighten the screws and add additional screws to secure the node. **Use two screws on each rack ear.**

## Four-Post Rack Mounting

To mount the GigaVUE-HCT in a four-post rack, use the rack ears and screws. The rack ears attach at the front of the unit:

- Attach the rack ears so they face towards the front of the system for mounting in four-post racks.
- Support is not required at the rear end of the chassis.

Refer to [Figure 10 Four-Post Rack Installation \(Single Chassis Assembly\)](#) for the four-post rack installation using the rack ears.



**Figure 10** *Four-Post Rack Installation (Single Chassis Assembly)*

# Installing and Removing Modules Procedure

The procedure for installing modules is to remove the filler panels, install the module, then fasten with the ejector lever and tighten the thumb screw on top of the lever. The following procedure has the details.

## Hot Swapping Modules

Modules are hot-swappable – they can be installed or removed from the chassis with the power on. **To remove a module safely with the power on, you must follow the procedure in [Module Removal and Replacement Procedure \(Hot Removal\)](#).**

**Install proper software versions prior to inserting any new modules.**

Gigamon often makes new modules available for GigaVUE-HCT nodes. New modules are usually introduced starting with a new software release. Make sure you install the supporting software release before physically installing the new module.

If you do install a new module before its supporting release, the module will appear in the **show cards** output with an **Operational Status** of **unsupported**.

In some cases, if you subsequently upgrade the node to the release that does support the new module, it can appear persistently in the **show cards** output with an **Operational Status** of **inserted**. To make the module operational, you must unconfigure it with the **no card slot x** command, followed by configuring the module with **card slot x**.

## Module Installation Procedure

Use the following procedure to install GigaVUE-HCT modules:

1. Make sure you are wearing an ESD-preventive wrist or ankle strap.
2. Locate the modules and remove them from their packaging.
3. Remove the protective filler panels from the target bays for all modules to be installed. Keep the filler panels so they can be easily reused if the module is ever removed. You can install modules in the front bay on the GigaVUE-HCT.

**NOTE:** To prevent any improper air flow and overheating the node, **do not leave any bays uncovered.**

4. Pull out the lever on the top of the module. Carefully slide the module into the bay. Push the lever back in and tighten using the thumb screw on the lever.



**Figure 11** *Installing Modules*

5. Replace any other modules by repeating the previous two steps.

**NOTE:** The first time you install a module in the node, you need to configure the node to recognize it with the **card** command and save your changes with **write memory**. Refer to [Configuring Basic GigaVUE HC Series Settings](#) for details.

**This completes the installation of the modules on the GigaVUE-HCT.**

## Module Removal and Replacement Procedure (Hot Removal)

Use the following procedure to remove a module from the GigaVUE-HCT node with the power on.

**IMPORTANT:** Hot removal of modules without following the listed steps can cause system instability and require a reboot.

Before starting, make sure you are wearing an ESD-preventive wrist or ankle strap.

### Replacing a Module with the Same Type of Module

1. Shut down the module to prepare for removal with the following CLI command:

```
(config) # card slot <slot id> down
```

2. Slide the module out of the chassis and store it in a static-safe location.
3. Insert the new module of the same type.

## Replacing a Module with a Different Type of Module

1. Remove all packet distribution configuration related to the module using the following CLI command:

```
(config) # no card slot <slot ID>
```

2. Slide the module out of chassis and store it in a static-safe location.
3. Insert the new module of the different type.
4. Issue the following CLI command to make the card available for configuration:

```
(config) # card slot <slot ID>
```

## Fan Replacement Procedure

The replacement procedure would take less than 15 seconds. The fans provided are not hot-swappable. To remove a fan, do the following:

1. Power down the GigaVUE-HCT device.
2. Press the black tab toward the center of the fan module handle to release the latch and then pull.

To insert a fan module, proceed as follows:

1. Power down the GigaVUE-HCT device.
2. Insert the fan module into the empty slot and slide it until it is flush with the rear of the chassis, and it will not slide in any further.

## Next Steps

Refer to [Configuring Basic GigaVUE® HC series Settings](#) for information on connecting with the GigaVUE-OS to make your initial configuration settings.

# Basic GigaVUE HC Series Connections and Configuration

This chapter describes how to establish your first configuration session with the GigaVUE-HCT and set the basic initial configuration options necessary to get the node up and running.

Refer to the following sections for details:

- Connecting Power to the GigaVUE-HCT
- Connecting Serial Console and Mgmt Ports
- Configuring BasicGigaVUE HC Series Settings
  - Access the Command-Line Interface over the Console Port
  - Run the Jump-Start Script
  - Configure Modules and Enable Ports
- Command-Line Basics
  - Command-Line Modes
  - Entering Commands in the CLI
  - Command-Line Syntax – Entering Commands
- The Basic Commands
- Completing the Initial GigaVUE HC Series Setup

## Connecting Power to the GigaVUE-HCT

The GigaVUE-HCT supports an AC power adapter in a 1+1 redundant configuration. In all cases, only a single power adapter is required to operate the node. However, connecting both adapters in a 1+1 configuration provides redundant power. The steps to connect power adapters are as follows:

1. Plug the power adapter DC header into each power input connector at the rear of the GigaVUE-HCT.

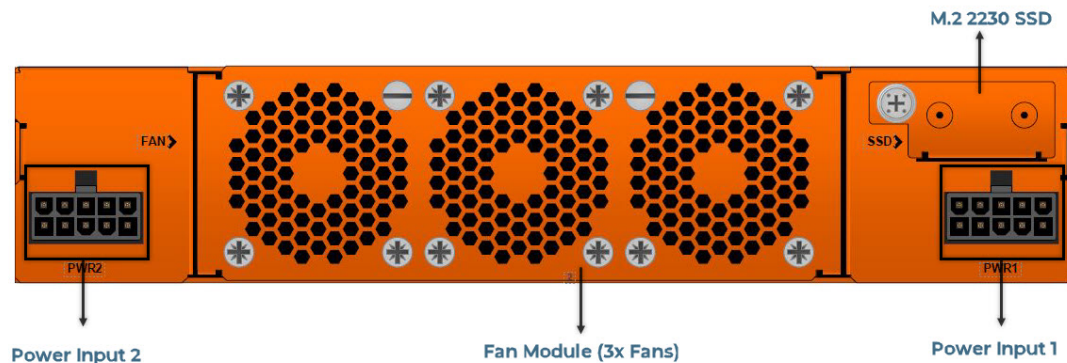

2. Plug an approved C5 power cable into each of the power adapters. Plug the other end of the power cables into a power source that can supply adequate power. For optimal power protection, plug the power adapters into separate circuits.

**NOTE:** To avoid disk corruption, please ensure the "reload halt" command is executed before an ungraceful power shutdown.

3. When connecting to an external AC power source, ensure that a Surge Protective Device (SPD) is installed at the AC power inlet.

4. Once the power supply is turned OFF, wait for 1 minute (60 seconds) before turning the power supply ON for GigaVUE-HCT.

To remove or replace a power adapter, refer to [Remove or Replace the Power Adapter](#)

## Remove or Replace the Power Adapter

To remove or replace a power adapter, follow below steps:

1. Disconnect the AC power cord to power down the adapter.
2. Disconnect adapter's DC header.
3. If a new adapter is needed, replace the adapter and connect it back.
4. Repeat the first and second steps for other power adapter in the GigaVUE-HCT chassis.

## Connecting Serial Console and Mgmt Ports

**To make basic GigaVUE-HCT connections (serial console and Mgmt ports):**

1. Locate the DB9-to-RJ45 serial cable provided with the GigaVUE-HCT. This cable is called a *console cable*.

**NOTE:** This cable is Cisco-compatible. Refer to [Appendix D, Console Port Signaling and Cabling](#) for pinout details.

2. Connect the RJ45 end of the console cable to the **console** port shown in the [Front View of GigaVUE-HCT Chassis](#).
3. Connect the DB9 end of the console cable to a PC's COM port.
4. Connect a standard Ethernet cable (Cat5e or better) to the 10/100/1000 **Mgmt** port on the chassis.
5. Connect the other end of the Ethernet cable to an Ethernet network.



# Configuring Basic GigaVUE® HC series Settings

This section describes how to perform the initial configuration of basic GigaVUE® HC series node settings over a serial terminal connection to the console port.

The system administrator must initially log in with a default **admin** account using a default password and then must immediately change the password through the **jump-start** script. Refer to [Access the Command-Line Interface over the Console Port](#).

Once you have used the console port to configure the Mgmt port's network properties, you can configure the GigaVUE® HC series node remotely using the Mgmt port's network connection.

The same commands are available in the GigaVUE-OS command-line interface regardless of whether you are connected over the Mgmt or console port.

## Access the Command-Line Interface over the Console Port

Use the console port on the left side of the base chassis to access the GigaVUE-HCT as follows:

1. Make the basic power and console cable connections described in [Connecting Serial Console and Mgmt Ports](#) and power on GigaVUE-HCT.
2. Start a terminal application on the PC. Common terminal applications include TeraTerm, PuTTY, and Hyperterminal.
3. Select the COM port connected to the console cable attached to the control module. For example, **COM1**.
4. Configure the port settings for the console connection as follows:
  - o **Bits per second** – 115,200
  - o **Data bits** – 8
  - o **Parity** – None
  - o **Stop bits** – 1
  - o **Flow control** – None

[Figure 12 Setting COM Port Properties for the Console Connection](#) shows an example of how these settings are configured in Hyperterminal.

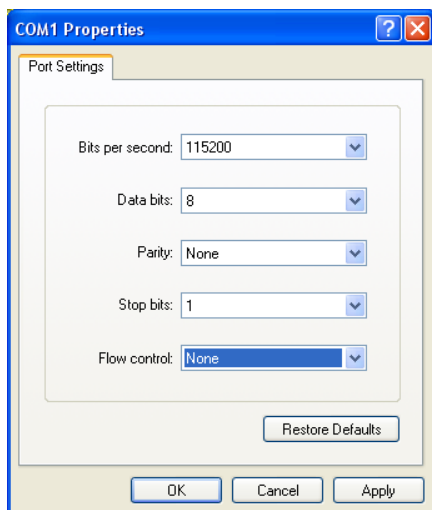

**Figure 12** Setting COM Port Properties for the Console Connection

5. Start the terminal connection. You may need to press **Enter** a few times before you see the **login:** prompt.
6. Log in to the command-line interface with the following default user account and password:

**User:admin**

**Password:admin123A!**

The **configuration jump-start** automatically starts and forces a password change. The system administrator must change the password on the default **admin** account through the **jump-start** script. The default password (admin123A!) is no longer allowed. Refer to [Run the Jump-Start Script](#) for details.

A password must meet the following standards:

- include 8-64 characters
- include at least one numeral
- include at least one upper-case letter
- include at least one lower case letter
- include at least one special character (for example, !, @, #, \$, %, ^, &, or \* – ASCII 0x21, 0x2F, 0x3A, 0x40, 0x5B, 0x5F, 0x7B, 0x7E)
- Must not include the user name or parts of full-name.

At the Admin password? prompt in the **jump-start** script, enter a new password that meets the standards, and then confirm the password.

## Run the Jump-Start Script

Gigamon provides GigaVUE HC Series H Series nodes with a **jump-start** script that walks you through the process of configuring basic settings. Run this script as follows:

1. Switch to **Configure** mode.

The GigaVUE HC Series H Series provides three command entry modes, each with increasingly powerful rights – **Standard**, **Enable**, and **Configure**. The jump-start script is only available in Configure mode:

- a. Type **en <Enter>** to switch to Enable mode.

The system prompt changes from **[hostname] >** to **[hostname] #**.

- b. Type **config t <Enter>** to switch to Configure mode.

The system prompt changes from **[hostname] #** to **[hostname] (config) #**.

2. Run the jump-start script with the following command:

**(config) # config jump-start**

3. Follow the jump-start script's prompts to configure each of the settings listed in the following table.

**NOTE:** If you change your mind about a particular setting, you will have a chance to change it at the end of the script.

<b>Hostname</b>	The hostname appears in the system prompt and is used to identify the chassis in SNMP traps.
<b>Management Port Network Settings</b>	Use either DHCP or specify a static IP address and netmask. If you do not use DHCP, you are prompted to configure the following additional options: <ul style="list-style-type: none"> <li>■ <b>Default Gateway</b> Supply the IP address of the default gateway for the node.</li> <li>■ <b>DNS Server</b> Supply the IP address of the DNS server for the node. A valid DNS server is required for successful use of TACACS+.</li> <li>■ <b>Domain Name</b> Supply the domain name for the node (for example, mycompany.com).</li> </ul>
<b>Enable IPv6?</b>	You can enable the use of IPv6 for the management port. IPv6 is used in addition to IPv4 if you enable this option. If you enable the IPv6 you have the option of enabling IPv6 auto-configuration or specifying a static address.

<b>Security Settings</b>	<p>Enable the following security settings:</p> <ul style="list-style-type: none"> <li>▪ <b>secure cryptography mode</b></li> <li>▪ <b>secure passwords mode</b></li> <li>▪ <b>minimum password length</b></li> </ul> <p>Refer to the <b>GigaVUE-OS CLI Reference Guide</b> for information on security.</p>
<b>Admin Password</b>	<p>The password for the <b>admin</b> account must be changed to a non-default password.</p>
<b>Cluster Enable?</b>	<p>Enable cluster support if this node will be a part of a cluster of connected GigaVUE HC Series nodes. If you enable cluster support, the jump-start script prompts you to supply the <b>Cluster ID</b>, <b>Cluster Name</b>, and <b>Cluster Mgmt Virtual IP Address</b>. You can join an existing cluster by supplying values that match existing settings.</p> <div style="border: 1px solid #ccc; padding: 5px; margin: 10px 0;"> <p><b>NOTE:</b> For clustered nodes configured to use the eth1 port on a control card as both the Mgmt and Cluster Management port, keep in mind that NTP is also used over the eth0 Mgmt port on the GigaVUE HC Series H Series node. In a case like this, you can only use one or the other.</p> </div> <p>If clustering is enabled, you will not be prompted for a box ID in the next step.</p> <p>Refer to the <i>GigaVUE-OS CLI Reference Guide</i> for information on setting up a cluster.</p>
<b>Box ID for the Node</b>	<p>Supply a numerical box ID for the node. This box ID is used to identify network/tool ports in the node – the format is box ID/ slot ID/port ID.</p> <p>You will be prompted for a box ID only if clustering was not enabled in the previous step.</p>

4. Review your settings. You can change a setting by specifying its listed line number and re-entering the setting.
5. When you are satisfied with your settings, exit the script as prompted. GigaVUE HC Series automatically saves your settings.
6. Restart the node with the **reload** command.

## Need to Change Any Settings?

If you need to change any of the settings you made in the jump-start script, you can either run the script again or change individual settings using the following commands in the Configure command mode:

- Use the **hostname** command to change the node's hostname.

- Use the **interface eth0** command to reconfigure or fine-tune Mgmt port settings, including basic IP settings (DHCP or static address and subnet mask) and physical parameters (duplex, MTU, and speed).
- Use the **ip** command to change the default gateway, DNS server, and domain name.
- You can also use the **username admin password <password>** command to change the **admin** user's password.

Refer to [The Basic Commands](#) for a quick summary of the available GigaVUE HC Series H Series commands.

## Configure Modules and Enable Ports

Modules must be configured and ports enabled before they can be used on the GigaVUE-HCT. Use the following procedure to bring up all modules and enable ports before starting to issue commands in the CLI:

1. Connect to console port as described in the previous section.
2. Wait at least two minutes after the system prompt appears for the modules to be initialized and then switch to **Configure** mode.

The GigaVUE HC Series provides three command entry modes, each with increasingly powerful rights – **Standard**, **Enable**, and **Configure**. The jump-start script is only available in Configure mode:

- a. Type **en <Enter>** to switch to Enable mode.

The system prompt changes from **[hostname] >** to **[hostname] #**.

- b. Type **config t <Enter>** to switch to Configure mode.

The system prompt changes from **[hostname] #** to **[hostname] (config) #**.

3. Reset the terminal settings to match the current window with the following command:

**(Config) # terminal resize**

4. Use the following command to check module status:

**(Config) # show cards**

5. Verify the following in the **show cards** output:
  - **Box ID** is not empty.
  - **Config** shows **yes** for all cards.
  - **Oper Status** shows **up** (or **inserted**) for all modules.
6. If **Config** does not show **yes** for all modules after two minutes, take the action corresponding to your **show cards** output, as follows:

show cards Output:	Corrective Action
<b>Config</b> does not show <b>yes</b> for any modules (including base chassis)	<b>(config) # chassis box-id &lt;integer&gt;(config) # card all</b>
<b>Config</b> shows <b>yes</b> for base chassis but not one or more modules	<b>(config) # card all</b>

The **card all** command configures the node for all currently unconfigured modules. However, it can only be used after the node's box ID has been configured as reported at the top of the **show cards** command output.

- Use the **show cards** command again to verify the output.

The **show cards** command output for a GigaVUE-HCT displays the properly configured modules.

```
HCT (config) # sh card
Box ID: 5
Slot  Config Oper Status  HW Type          Product Code  Serial Num  HW Rev
-----
cc1   yes    up    HCT-Main-Board-HW  132-00HA     1HA0-0040   1.3-0f
1     yes    up    HCT-C02-HW        132-00HM     1HM0-0040   1.3-f
2     yes    up    TAP-HC1-G10040-HW  132-00D8     1D80-0016   2.0-22
```

- Issue a **show port** command to determine the port numbers that need to be enabled.
- Use the **port** command with the **admin** argument to enable ports on modules as well as ports on the base chassis. For example, the following command enables all ports on the 10Gb ports on the base chassis:

```
(config) # port 1/1/x1..x8 params admin enable
```

- Save your changes so that the cards and ports come up automatically at the next reboot:

```
(config) # write memory
```

## Command-Line Basics

This section provides a quick orientation to the GigaVUE-OS command-line interface – how to enter commands, get help, and so on.

## Command-Line Modes

The GigaVUE-OS can operate in one of three modes, each with its own set of available commands – Standard, Enable, and Configure. When you first launch the CLI, you start in Standard mode with access to a limited number of commands to review node status. As you

move from **Standard** mode to **Enable** mode to **Configure** mode, the power and the number of commands available increase, as summarized in [Figure 13 GigaVUE-OS Command-Line Modes](#).

## Differences in Commands for admin and default Level Users

The commands available in the GigaVUE-OS differ depending on whether you are logged in as **admin** or **default** level user. Commands listed in bold in [Figure 13 GigaVUE-OS Command-Line Modes](#) are only available to **admin** level users.



Figure 13 GigaVUE-OS Command-Line Modes



**NOTE:** If you are working simultaneously with multiple GigaVUE HC Series nodes, you may want to assign each a separate hostname so its easy to identify separate terminal sessions from the system prompt. Admin users can do this in Configure mode with the **hostname <name>** command.

## Entering Commands in the CLI

The GigaVUE-OS provides several conventions that make it easy to identify available commands and enter them quickly:

Technique	Description
Context-Sensitive Help	<p>The <b>?</b> symbol is the key to receiving help wherever you are in the CLI:</p> <ul style="list-style-type: none"> <li>Type <b>?</b> by itself to see a list of all available commands.</li> <li><b>Word Help</b> – Type a partial word with <b>?</b> mark immediately following the partially-typed word to see a list of all possible commands using the word entered so far. For example, if you typed <b>r?</b> in Configure mode, the CLI would return the following possible commands based on what you have entered so far: <b>radius-server Configure RADIUS server settings reload Reboot or shut down the system reset Reset this system to its factory state</b></li> <li><b>Command Help</b> – Type a command followed by a question mark to see all possible arguments for the command as entered. If the node returns <b>&lt;cr&gt;</b>, that means the command can be entered as-is. For example, if you entered <b>gigastream ?</b>, you would see <b>alias</b>. You can build your way through the entire command tree by entering <b>?</b> after each new argument. For example, after entering <b>gigastream alias myalias ?</b>, you would see the next valid argument – <b>port-list</b>.</li> </ul> <p><b>NOTE:</b> Typing <b>?</b> accesses the help system immediately – you do not need to press <b>&lt;Enter&gt;</b>.</p>
Partial Command Entry	<p>For all GigaVUE HC Series commands and arguments, you only need to enter enough characters to distinguish the command from all other available commands. So, for example, you do not have to enter the full command <b>debug</b> – there is only one command starting with the letter <b>d</b>, so you only have to enter <b>d</b>.</p>
Command Completion	<p>If you have partially typed a command, you can press <b>Tab</b>, and the CLI will attempt to complete the command based on what has been entered so far.</p>

Technique	Description
	<p>Use the command completion feature with partial command entry – you can press Tab while entering a command to see a list of all available commands matching what you have entered so far. For example, you can press <b>p&lt;Tab&gt;</b> and the node will return:</p> <p><b>ping ping6 port port-group port-pair ptp</b></p> <p>Based on this information, you only need to enter <b>pt</b> to distinguish the <b>ptp</b> command from the other commands beginning with the letter <b>p</b>.</p>

## Command-Line Syntax – Entering Commands

You enter all configuration commands for the GigaVUE-OS in the command-line interface. Enter commands by typing enough characters to uniquely identify the command and pressing **<Enter>**.

When entering commands, keep in mind the following rules:

- Successful commands return no response in the CLI; commands with errors return an error response beginning with **%**, followed by a short error description.
- All commands are case-sensitive.
- Aliases are case-sensitive and accept both lower and upper case – for example, **my\_alias** and **My\_Alias** refer to two separate maps.
- The **no** command is used to remove configuration settings. For example, **no connect alias myconnect** deletes the named **myconnect**.
- Port numbers are entered in **<chassis-id>/<slot-num>/<port-num>** format. For example, **1/1/x1** identifies the 1Gb/10Gb port x1 in slot 1 on box 1.
- Strings must consist entirely of alphanumeric characters with no spaces. The only exceptions are the underscore (**\_**) and hyphen (**-**) characters. Those are allowed.

For example, in Configure mode, **port 1/1/x1 alias My\_Alias** is legal, but **port 1/1/x1 alias My Alias** is not.

**NOTE:** Some string fields do accept spaces provided the input is made inside quotation marks (for example, the **banner login** command described in [Using a Custom Banner](#)).

## Configure Mode Syntax

Users of GigaVUE® HC series nodes may be accustomed to entering the word **config** before many commands – **config map**, **config port-filter**, and so on. When using the GigaVUE-OS, the “config” part of the command is implied whenever you are working in Configure mode. The system prompt helps you remember this by including the word **(config)** in parentheses. For example:

```
(config) #
```

So, instead of entering **config gigastream** to set up a GigaStream consisting of multiple ports, you just enter **gigastream** followed by the necessary arguments. The **config** part is implied because you are already working in the Configure mode. For example:

```
(config) # gigastream alias mystream port-list 1/1/x1..x4
```

## Paging through CLI Output

By default, the CLI returns output exceeding the configured terminal length in pages. The CLI provides the same features for working through the paged output as the Linux programs **less** and **more**. Press the **h** key when presented with the paging prompt at the base of the display to see paging options – [Figure 14 Viewing Paging Options](#) provides an example of how to do this.

If you prefer, you can disable paging either for the current session or by default:

- **Disable for Current Session**(config) # no cli session paging enable
- **Disable for All Sessions (Default)**(config) # no cli default paging enable

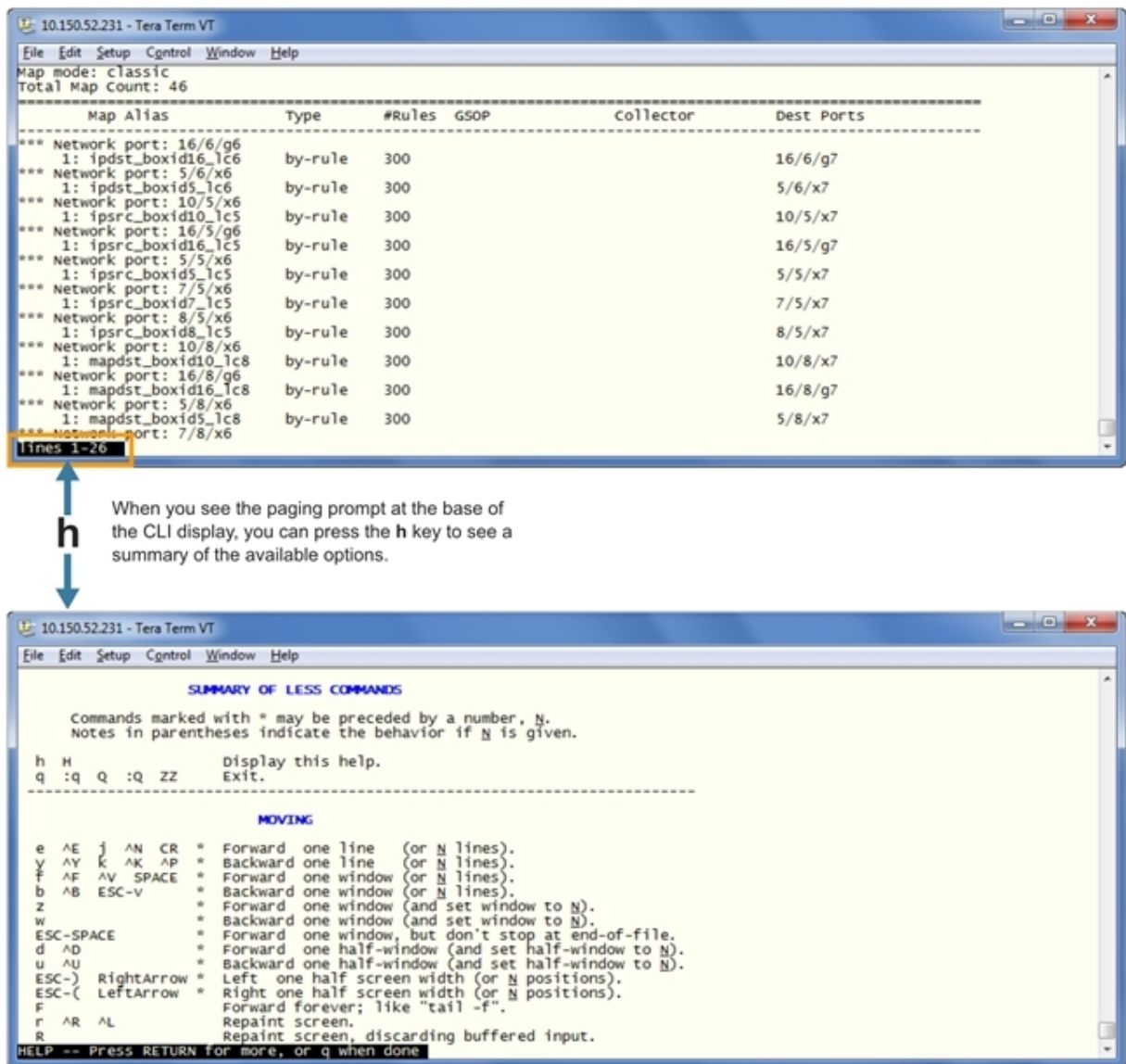

Figure 14 Viewing Paging Options

# Command-Line Syntax – Entering Commands

You enter all configuration commands for the GigaVUE-OS in the command-line interface. Enter commands by typing enough characters to uniquely identify the command and pressing **<Enter>**.

When entering commands, keep in mind the following rules:

- Successful commands return no response in the CLI; commands with errors return an error response beginning with **%**, followed by a short error description.

- All commands are case-sensitive.
- Aliases are case-sensitive and accept both lower and upper case – for example, **my\_alias** and **My\_Alias** refer to two separate maps.
- The **no** command is used to remove configuration settings. For example the **no connect alias myconnect** deletes the named **myconnect**.
- Port numbers are entered in **<chassis-id>/<slot-num>/<port-num>** format. For example, **1/1/x1** identifies the 10Gb/1Gb port x1 in slot 1 on box 1.
- Strings must consist entirely of alphanumeric characters with no spaces. The only exceptions are the underscore (\_) and hyphen (-) characters. Those are allowed.  
For example, in Configure mode, **port 1/1/g1 alias My\_Alias** is legal, but **port 1/1/g1 alias My Alias** is not.

**NOTE:** Some string fields do accept spaces provided the input is made inside quotation marks (for example, the **banner login** command described in [Using a Custom Banner](#)).

## Configure Mode Syntax

Users of GigaVUE HC Series nodes may be accustomed to entering the word **config** before many commands – **config map**, **config port-filter**, and so on. When using the GigaVUE-OS, the “config” part of the command is implied whenever you are working in Configure mode. The system prompt helps you remember this by including the word **(config)** in parentheses. For example:

**(config) #**

So, instead of entering **config gigastream** to set up a GigaStream consisting of multiple ports, you just enter **gigastream** followed by the necessary arguments. The **config** part is implied because you already work in the Configure mode. For example:

**(config) # gigastream alias mystream port-list 1/1/x1..x4**

## Paging through CLI Output

By default, the CLI returns output exceeding the configured terminal length in pages. The CLI provides the same features for working through the paged output as the Linux programs **less** and **more**. Press the **h** key when presented with the paging prompt at the base of the display to see paging options – [Figure 15 Viewing Paging Options](#) provides an example of how to do this.

If you prefer, you can disable paging either for the current session or by default:

- **Disable for Current Session**(config) # no cli session paging enable
- **Disable for All Sessions (Default)**(config) # no cli default paging enable

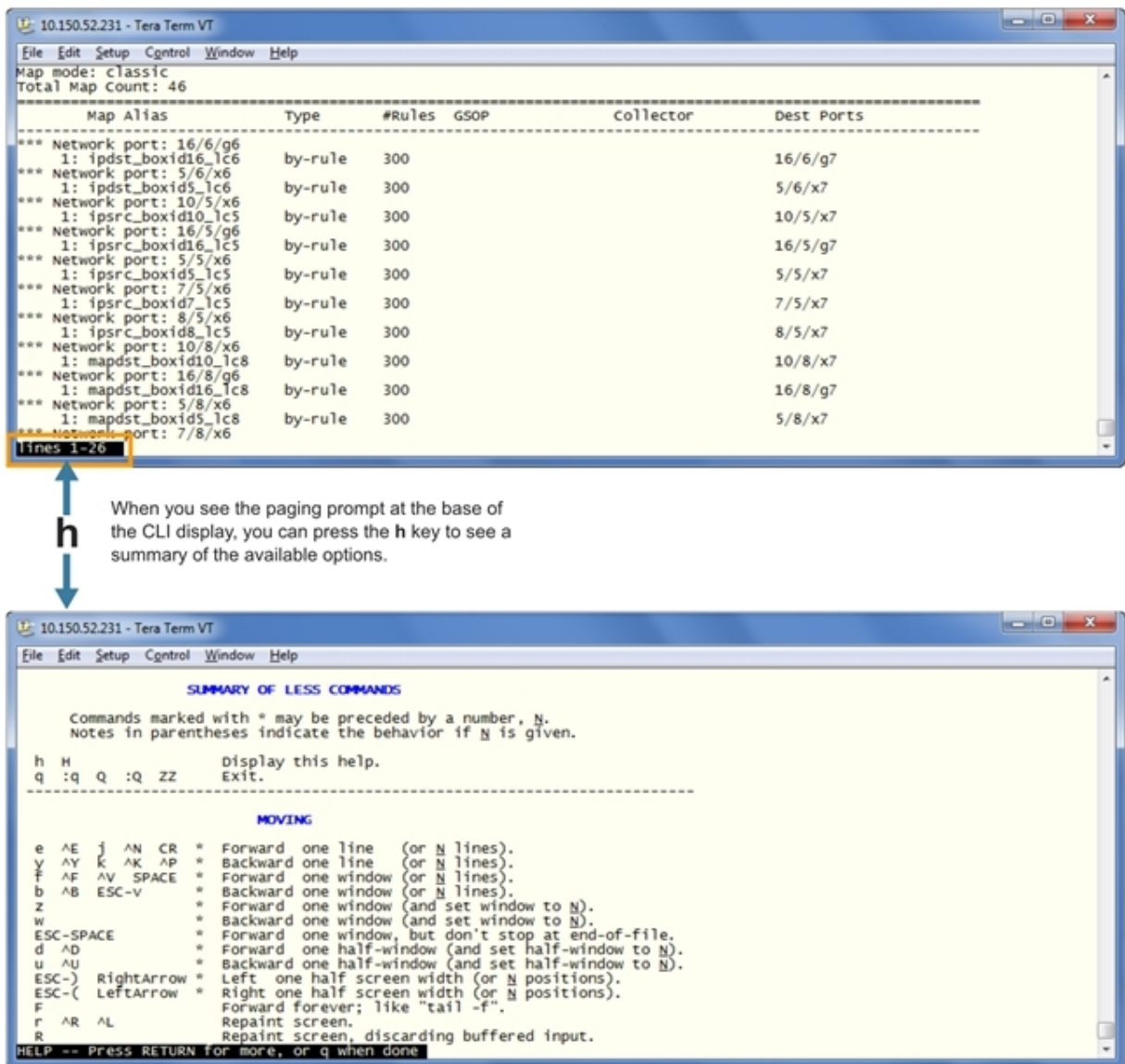

Figure 15 Viewing Paging Options

## The Basic Commands

The following table lists each of the top level commands for the GigaVUE-OS in Configure mode. As described in [Entering Commands in the CLI](#), the commands available in Configure mode are a superset of those available in Standard and Enable modes.

Most commands have multiple supported arguments. You can see the exact arguments available at any point of command entry by typing it into the CLI followed by **?**.

Table 3: CLI Commands

Command	Description
<b>aaa</b>	Configures authentication, authorization, and accounting setting
<b>apps</b>	Enables access to Gigamon Applications, such as Application Session Filtering (ASF), GTP backup, GTP whitelisting, inline SSL decryption, keystore, NetFlow, SIP whitelisting, and Passive SSL decryption. GigaSMART applications are not supported on GigaVUE TA Series.
<b>banner</b>	Sets a node login banner.
<b>bond</b>	Configures bonded interface settings.
<b>boot</b>	Configures node boot parameters.
<b>card</b>	Configures a line card or module.
<b>chassis</b>	Configures the GigaVUE HC Series H Series chassis.
<b>clear</b>	Resets statistics or clears caches.
<b>cli</b>	Configures CLI shell options.
<b>clock</b>	Sets the node clock or timezone.
<b>cluster</b>	Configures a cluster of connected GigaVUE-OS nodes.
<b>configuration</b>	Manages configuration files.
<b>configure</b>	Enters Configure mode.
<b>coreboot</b>	Upgrades the BIOS image on GigaVUE HC Series-TA100 and GigaVUE-HC1.
<b>crypto</b>	Manages X.509 certificates for the GigaVUE HC Series H Series node's Web server.
<b>debug</b>	Generates a dump file for use in debugging issues with Gigamon Technical Support.
<b>disable</b>	Exits Enable mode and returns to Standard mode.
<b>email</b>	Configures email and event notification via email.
<b>enable</b>	Enters Enable mode.
<b>exit</b>	Exits Configure mode and returns to Enable mode or logs out of the CLI.
<b>file</b>	Manages TCP and debug dump files on disk.
<b>filter-template</b>	Configures flexible filter templates on GigaVUE-HC3 and GigaVUE HC Series-TA100.
<b>gigasmart</b>	Configures an interface address to a GigaSMART card or module.
<b>gigastream</b>	Configures a GigaStream—a group of ports acting as a single addressable tool port destination or stack-link.
<b>gsgroup</b>	Configures a GigaSMART group consisting of one or more internal GigaSMART ports.
<b>gsop</b>	Configures a GigaSMART operation consisting of one or more advanced processing applications.
<b>gsparams</b>	Configures GigaSMART parameters.
<b>halt</b>	Shuts down the node without powering it off.
<b>hb-profile</b>	Configures a heartbeat profile on GigaVUE HC Series HC Series nodes.
<b>help</b>	Views a description of the interactive help system.
<b>hostname</b>	Specifies the node's hostname. The hostname appears in the system prompt and in SNMP traps.
<b>ib-pathway</b>	Reserved for future use.

Command	Description
<b><i>image</i></b>	Manages node software images.
<b><i>inline-network</i></b>	Configures an inline network on GigaVUE HC Series HC Series nodes.
<b><i>inline-network-group</i></b>	Configures an inline network group on GigaVUE HC Series HC Series nodes.
<b><i>inline-serial</i></b>	Configures an inline tool series on GigaVUE HC Series HC Series nodes.
<b><i>inline-tool</i></b>	Configures an inline tool on GigaVUE HC Series HC Series nodes.
<b><i>inline-tool-group</i></b>	Configures an inline tool group on GigaVUE HC Series HC Series nodes.
<b><i>interface</i></b>	Configures network interfaces.
<b><i>ip</i></b>	Configures IP settings for the eth0 Mgmt port.
<b><i>ipv6</i></b>	Configures IPv6 settings for the eth0 Mgmt port.
<b><i>job</i></b>	Configures scheduled jobs.
<b><i>ldap</i></b>	Configures LDAP server settings for authentication.
<b><i>license</i></b>	Activates features using license keys. Licensing is used for GigaSMART, Port, or Advanced Features License.
<b><i>logging</i></b>	Configures event logging.
<b><i>map</i></b>	Configures maps and map rules to manage GigaVUE HC Series traffic distribution.
<b><i>map-group</i></b>	Configures map groups for GTP forward listing and GTP flow sampling.
<b><i>map-passall</i></b>	Creates a pass-all map to send all traffic on a network port to a tool port irrespective of the other packet distribution in place on the port.
<b><i>map-scollector</i></b>	Configures shared collector map parameters.
<b><i>map-template</i></b>	Configures a map template.
<b><i>nhb-profile</i></b>	Configures a negative heartbeat on GigaVUE HC Series HC Series nodes.
<b><i>no</i></b>	Deletes or clears certain configuration options.
<b><i>notifications</i></b>	Configures notification settings.
<b><i>ntp</i></b>	Enables and disables the use of NTP, as well as adds NTP servers.
<b><i>ntpdate</i></b>	Sets node clock once from a remote server using NTP.
<b><i>ping</i></b>	Sends ICMP echo requests to a specified host.
<b><i>ping6</i></b>	Sends IPMPv6 echo requests to a specified IPv6 host.
<b><i>pld</i></b>	Upgrades programmable logic devices (PLDs) on GigaVUE-HC3 nodes.
<b><i>policy</i></b>	Configures an Active Visibility policy.
<b><i>port</i></b>	Configures port type, parameters, and filters.
<b><i>port-group</i></b>	Creates a group of ports.
<b><i>port-pair</i></b>	Configures a port-pair on a pair of network ports within the same GigaVUE HC Series H Series node. A port-pair is a bidirectional connection in which traffic arriving on one port in the pair is transmitted out the other (and vice-versa) as a pass-through TAP.
<b><i>ptp</i></b>	Enables and disables the use of PTP.
<b><i>radius-server</i></b>	Configures RADIUS server settings for authentication.
<b><i>redundancy-profile</i></b>	Configures an inline redundancy profile on GigaVUE HC Series HC Series nodes.



Command	Description
<b><i>reload (reboot)</i></b>	Reboots or shuts down the node.
<b><i>reset</i></b>	Resets specified portions of the node configuration to their factory states.
<b><i>serial</i></b>	Sets options for the serial console port.
<b><i>sfp</i></b>	Reserved for future use.
<b><i>show</i></b>	Displays configuration and status information for GigaVUE HC Series H Series settings and entities.
<b><i>sleep</i></b>	Sleeps for a specified number of seconds.
<b><i>snmp-server</i></b>	Configures SNMP settings, including the local SNMP server, notification events, and notification destinations.
<b><i>spine-link</i></b>	Configures spine links in a cluster with a leaf and spine architecture.
<b><i>ssh</i></b>	Enables and disables SSH access, as well as manages settings.
<b><i>stack-link</i></b>	Configures a stack-link between two GigaVUE HC Series H Series nodes in a cluster. Stack-links are used to carry data traffic between nodes in a GigaVUE HC Series H Series cluster.
<b><i>sync</i></b>	Enables dynamic control card synchronization for a GigaVUE HC Series-HD8 node.
<b><i>system</i></b>	Changes system settings.
<b><i>system-health</i></b>	Configures system health behaviors.
<b><i>tacacs-server</i></b>	Configures TACACS+ server settings for authentication.
<b><i>terminal</i></b>	Sets terminal parameters, including width and length.
<b><i>timestamp</i></b>	Configures the timestamp source.
<b><i>tool-mirror</i></b>	Configures a tool-mirror connection between two tool ports. A tool-mirror connection sends all packets arriving on one tool port to a second tool port on the same node.
<b><i>traceroute</i></b>	Traces the route packets take to a destination.
<b><i>tunnel</i></b>	Reserved for future use.
<b><i>tunnel-endpoint</i></b>	Configures a tunnel endpoint, which is a destination for load balanced traffic from a L2GRE encapsulation tunnel.
<b><i>tunneled-port</i></b>	Configures a tunnel port to be used for GigaSMART encapsulation/decapsulation operations.
<b><i>uboot</i></b>	Installs new uboot software.
<b><i>username</i></b>	Manages user accounts.
<b><i>vport</i></b>	Configures a virtual port.
<b><i>web</i></b>	Configures the Web server used for GigaVUE-FM GUI support on the GigaVUE HC Series H Series node.
<b><i>write</i></b>	Saves the running configuration to persistent storage.

# Completing the Initial GigaVUE® HC series Setup

At this point, you have logged in to the GigaVUE-OS command-line interface using the **admin** account, configured the **Mgmt** port's network properties for SSH access, and have explored the command-line interface structure.

There are a few more steps you should perform to complete the initial configuration before you get to the fun stuff – setting up network ports, tool ports, and mapping traffic. These tasks include:

- Switch to the Configure mode. Refer to [Enter the Configure Command-Line Mode](#).
- Configure SSH access to the node. Refer to [SSH](#).
- Configure the GigaVUE® HC series time and date options. Refer to [Configuring GigaVUE® HC series Time Options](#).
- Configure automatic email notifications for node events. Refer to [Configuring Automatic Email Notifications](#).
- Configure a custom login banner. Refer to [Using a Custom Banner](#).
- Save your changes!. Refer to [Saving Changes](#).

## Enter the Configure Command-Line Mode

Keep in mind that the GigaVUE-OS has three different command modes for the CLI – **Standard**, **Enable**, and **Configure**. The commands described in the following sections are all only available in Configure mode. Switch to Configure mode as follows:

Command	Notes
<b>&gt; enable</b>	You only need to supply enough of each command to positively identify it among the other available commands. So, in this example, you could just type <b>ena</b> and press Enter.
<b># configure terminal</b>	Similarly, this command can be entered as <b>co t</b> .
<b>(config) #</b>	Notice how the system prompt changes with each command mode. Command modes offer greater control over the node as you ascend from <b>Standard</b> to <b>Enable</b> to <b>Configure</b> .

# SSH

SSH2 is available for remote connections to the GigaVUE-HCT's **Mgmt** port. By default, SSH2 is enabled. Use the **ssh** commands in Configure mode to enable or disable the corresponding connections. To disable the corresponding connection, you include **no** before the command, as demonstrated in the following table. For example:

Command	Notes
Enable: <b>(config) # ssh server enable</b> Disable: <b>(config) # no ssh server enable</b>	When SSH2 is enabled, use any compliant SSH2 client to connect to the command-line interface remotely. For example, to connect using the popular SSH2 client, PuTTY: <ol style="list-style-type: none"> <li>Start PuTTY and enter the GigaVUE HC Series node's IP address in the Host Name field.</li> <li>Click the <b>SSH</b> protocol radio button.</li> <li>Click <b>Open</b> to open a connection. If this is your first connection PuTTY warns you that the host key presented by the GigaVUE HC Series node is not in your cache. You can add the key, connect without adding the key, or cancel the connection. Refer to <a href="#">Verifying Host Keys During Connection</a> for information on how to verify that the host key shown is the correct one.</li> <li>Log in with GigaVUE HC Series credentials.</li> </ol>

## Advantages of SSH2

SSH2 is a secure choice for remote connections, providing an encrypted channel instead of relying on clear text. It also provides stronger user authentication capabilities, including the use of a public **host key**. Host keys uniquely identify a server, helping guarantee that the server you are connecting to is the server you think it is.

GigaVUE HC Series includes default RSA v1/v2 and DSAv2-encrypted public host keys (SSH2 supports both RSA and DSA encryption algorithms). The first time you connect to GigaVUE HC Series with an SSH2 client, the client will warn you that the host keys are not in your local cache and show you the actual host key presented by the GigaVUE-HCT. Your client will most likely give you the option of trusting the key, and adding it to your local cache. Once you have trusted the key, your client will alert you during connection if a different key is presented.

## Verifying Host Keys During Connection

To verify that the host key presented during an SSH2 connection is in fact the GigaVUE HC Series node's, you can connect over the console port (refer to [Access the Command-Line Interface over the Console Port](#)) and use the **show ssh server host-keys** command to see the current public host keys and fingerprints for the GigaVUE-HCT. Paste these in a file and keep them nearby when you connect via SSH2 the first time. This way, you will be able to

compare the actual host key to what your SSH2 client says is being presented. Once you have verified that they are the same, you can choose to trust the host key, allowing future connections to take place seamlessly.

## Changing Host Keys

Use the **ssh server host-key generate** command to change the default host keys provided with the GigaVUE-HCT. The command has the following syntax:

```
ssh server host-key <rsa1 | rsa2 | dsa2> <private-key | public-key> generate
```

For example, to configure a new RSAv1 public hostkey, you could use the following command:

```
(config) # ssh server host-key rsa1 public-key generate
```

## Connecting to the GigaVUE HC Series Node from GigaVUE-FM

Use the following procedure to connect to a GigaVUE HC Series node using GigaVUE-FM.

**NOTE:** You can configure whether the GigaVUE HC Series node redirects all incoming HTTP connections to the HTTPS port with the **web http redirect** command.

1. Open a supported browser. Refer to the **GigaVUE Fabric Management Guide**.
2. Enter one of the following URLs:

```
https://<GigaVUE HC Series Node IP Address>http://<GigaVUE HC Series Node IP Address>
```

3. The first time you connect to GigaVUE-FM, your browser will prompt you regarding an invalid security certificate. Depending on the browser you are using, you can avoid these warnings either by installing a certificate or adding an exception. The following table has the details:

Browser	Add Exception?	Install Certificate?
Mozilla Firefox	Y	Y
Windows Internet Explorer	N	Y
Apple Safari		
Google Chrome		

**NOTE:** Gigamon provides the GigaVUE HC Series with self-signed certificates for use with GigaVUE-FM; you can also create and install a third-party certificate on these nodes.

Add an exception in Firefox as follows:

- a. Click the **Or you can add an exception** link.
- b. Click the **Add Exception** button.
- c. Click the **Get Certificate** button.
- d. Click the **Confirm Security Exception** button.

The GigaVUE-FM login page appears.

4. Enter a valid username and password and click **Login**.

### Configuring Internet Explorer for Use with GigaVUE-FM

GigaVUE-FM works best in Internet Explorer when the browser is configured to check for newer versions of stored pages every time pages are visited. Enable this option as follows:

1. Open Internet Explorer.
2. Select the **Tools > Internet Options** command.
3. In the **General** tab, locate the **Browsing history** section and click its **Settings** button.
4. Set the **Check for newer version of stored pages:** option to **Every time I visit the webpage**.
5. Click **OK** on the Temporary Internet Files and History Settings dialog.
6. Click **OK** on the Internet Options dialog.

### Next Steps?

Refer to the online help for details on configuring and operating the GigaVUE-HCT from the GigaVUE-FM interface. Keep in mind that each of the initial configuration settings described in the rest of this chapter can also be set in GigaVUE-FM.

## Configuring GigaVUE<sup>®</sup> HC series Time Options

The GigaVUE<sup>®</sup> HC series node includes a variety of features for setting the time, including:

Method	CLI Command	For more information:
System Clock	<code>clock set hh:mm:ss yyyy/mm/dd</code>	<a href="#">Setting Time Manually</a>
One-Time NTP	<code>ntpdate &lt;ntpserver</code>	<a href="#">Performing One-Time NTP Server Synchronization</a>

Method	CLI Command	For more information:
Synchronization	<b>address&gt;</b>	
Persistent NTP Synchronization	Add server using <b>ntp server</b> command. Enable use of ntp with <b>ntp enable</b> command.	<a href="#">Using NTP Time Server for Clock Synchronization</a>
PTP Synchronization	Enable PTP with <b>ptp enable</b> command.	<i>Refer to the GigaVUE-OS CLI Reference Guide (Reserved for future use)</i>

## Setting Time Manually

The easiest way to set the GigaVUE® HC series node's time is manually with the **clock set** command. For example:

```
(config) # clock set 05:18:38 2015/01/06
```

**NOTE:** Even if you are using NTP, configure time manually as well. The GigaVUE® HC series node will automatically fall back to the manual time setting if it is unable to synchronize with the specified time server.

The **show ntp** command shows the current state of the NTP server in use; the **show clock** command shows the current GigaVUE® HC series node's time.

## Performing One-Time NTP Server Synchronization

You can perform a one-time synchronization with an NTP server using the **ntpdate** command. For example:

```
(config) # ntpdate time.nist.gov
```

**NOTE:** This method does not provide updates to correct clock drift over time. It is generally preferable to use persistent NTP synchronization with the **ntp** commands.

## Using NTP Time Server for Clock Synchronization

The GigaVUE® HC series node can optionally use one or more NTP servers for its time setting. Use the following procedure to add an NTP server to the GigaVUE® HC series node's list and enable the use of NTP.

1. Specify the address of the time server. For example, if the time server is on 192.168.1.10, you would use the following command:

```
(config) # ntp server 192.168.1.10
```

**NOTE:** There are many public NTP servers available on the Internet.

2. Turn on NTP with the following command:

**(config) # ntp enable**

- The GigaVUE® HC series node connects to the specified NTP server and synchronizes to its time.
- NTP reports times in UTC. Because of this, it is a good idea to specify the GigaVUE® HC series node's timezone so that UTC can be converted to the local timezone.

You specify the timezone either in terms of the offset from UTC (either plus or minus) or with a particular location's name, depending on the argument you choose for the **clock timezone** command:

- **Offset from UTC** – Set the timezone as an offset from UTC with the **UTC-offset** argument. For example, the following command sets the timezone as eight hours earlier than UTC:  
**(config) # clock UTC-offset UTC-8**
- **Location** – You can specify a particular location's timezone to use. The easiest way to do this is to build the available list of cities by adding a space and a question mark after each subsequent zone word. For example, enter **(config) # clock timezone ?** to see the list of available locations. Select a location and use the same question mark technique to see the next available zone words. This way, you can build out to the exact location you need. For example:

**(config) # clock timezone America North United\_States Pacific (config) # clock timezone Asia Eastern Hong\_Kong**

Once you have finished configuring NTP options, use the **show ntp** command to check the status of clock synchronization ([Configuring GigaVUE® HC series Time Options](#)).

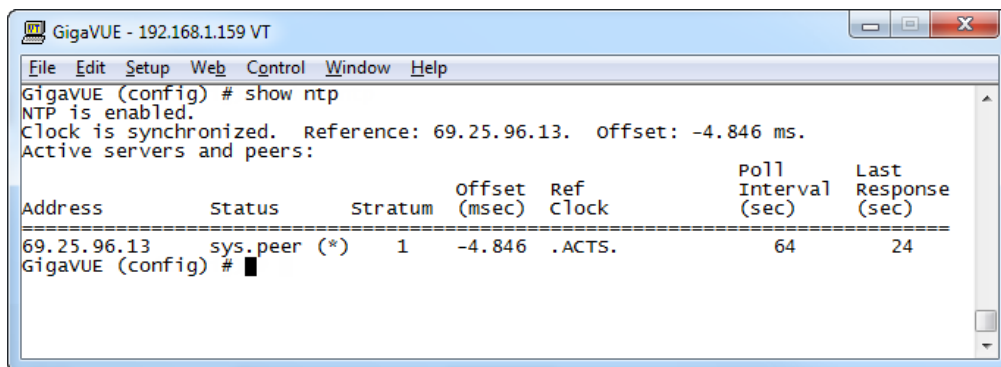

```
GigaVUE (config) # show ntp
NTP is enabled.
Clock is synchronized. Reference: 69.25.96.13. Offset: -4.846 ms.
Active servers and peers:
-----
Address          Status      Stratum  Offset  Ref      Poll      Last
(msec)          (msec)      Clock    (msec)  Clock    Interval  Response
(sec)
-----
69.25.96.13     sys.peer (*) 1        -4.846  .ACTS.   64        24
GigaVUE (config) #
```

**Figure 16** Checking NTP Status and Configuration

## Configuring Automatic Email Notifications

The GigaVUE HC Series node provides powerful email notification capabilities, automatically sending emails to specified addresses when any of a wide variety of events take place on the node. Gigamon strongly recommends that you configure this feature so you have immediate visibility of events affecting node health.

You configure automatic email notifications with the **email** command and its arguments. Start by making sure the CLI is in Configure mode. If the **(config)** entry appears in the

system prompt, you are in Configure mode. If not, use the **enable** and **configure terminal** commands sequentially to change to Configure mode. Then, configure email notifications as follows:

Description	Command
<p>First, use the <b>email mailhub</b> command to specify the mail server to use for notification emails. In this example, we are using the email server named <b>smtp.emailsrvr.com</b>. You could also supply an IP address instead of a hostname.</p>	<pre>(config) # email mailhub smtp.emailsrvr.com</pre>
<p>Next, use the <b>email auth</b> command to supply the email account username and password. In this example, we are using <b>alerts@mycompany.com</b> with the password of <b>mypassword123</b>.</p>	<pre>(config) # email auth username alerts@mycompany.com (config) # email auth password mypassword123</pre>
<p>Now that we have set up the account to use, we will turn on email authentication.</p>	<pre>(config) # email auth enable</pre>
<p>Now that we have configured the settings that let the node send emails, set up who to send them to and when to send them. Use <b>email notify recipient</b> to configure the destinations for event notification emails. You can specify multiple destinations separated by commas with no spaces.</p>	<pre>(config) # email notify recipient cday@mycompany.com,mfelton@mycompany.com</pre>
<p>The <b>email notify event</b> command lets you configure which events will trigger automatic emails. There are quite a few events available – start by entering <b>email notify event ?</b> to see the list of available events. You can either enable individual events, or, use the <b>all</b> argument to enable them all. We are going to start with the <b>all</b> setting and tune settings as necessary later on.</p>	<pre>(config) # email notify event all</pre>



Description	Command
<p>It is a good idea to check your settings and make sure emails are sent successfully. You can do that with the <b>email send-test</b> command. If you do not receive the email, check the <b>show log</b> output to make sure the email was sent. Then, reconfigure email settings, if necessary.</p>	<p><b>(config) # email send-test</b></p>
<p>You may also want to configure and enable <b>autosupport</b> emails. Autosupport emails are sent directly to Gigamon's Technical Support department when specified events take place, enabling proactive problem resolution. The GigaVUE HC Series node is preconfigured with the correct destination address – you just need to enable the feature with the following command.</p> <p>Use <b>show email events</b> to see the list of events for which auto support emails will be sent. You can change the list with the <b>(no) email autosupport event</b> command.</p>	<p><b>(config) email autosupport enable</b></p>
<p>Emails will now be sent automatically to the configured addresses when any selected events occur. There are many other options for fine-tuning automatic email settings, including how to handle “dead letters” (emails that did not reach their recipient), how the email address of the GigaVUE HC Series node should appear, the port for the email server, the reply-to address, and so on. Refer to the <b>GigaVUE-OS CLI Reference Guide</b> for details.</p>	

## Using a Custom Banner

The GigaVUE HC Series node can display a customizable text banner at node startup before a user logs in. This way, users connecting to the node see the banner before they log in, giving them an idea of which node they are logging in to. The banner also appears after a user logs out.

Use the **banner login “<string>”** command to configure the login banner. For example:

```
(config) # banner login "Pacific Call Center"
```

**NOTE:** You only need to use quotation marks for the <string> if it includes spaces.

The next time you log in or out of the GigaVUE HC Series node, you will see the customizable banner.

## Saving Changes

It is a good idea to use the **write memory** command to save changes as you make them. Later on, when you start setting up packet distribution with connections and maps, your changes will be added to the active configuration right away but will not be saved across a node reboot unless you use the **write memory** command to save your changes to flash.

**NOTE:** The name of the factory-provided configuration file is **initial**. You can see the name of the most recently booted configuration file by using the **show running-configuration** command (or **show configuration**) and look for the **## Running database** entry. In [Figure 17 Showing the Current Configuration File](#), you can tell that the GigaVUE HC Series node is currently operating with the **initial** configuration file.

Refer to the **GigaVUE-OS CLI Reference Guide** for details on using configuration files.

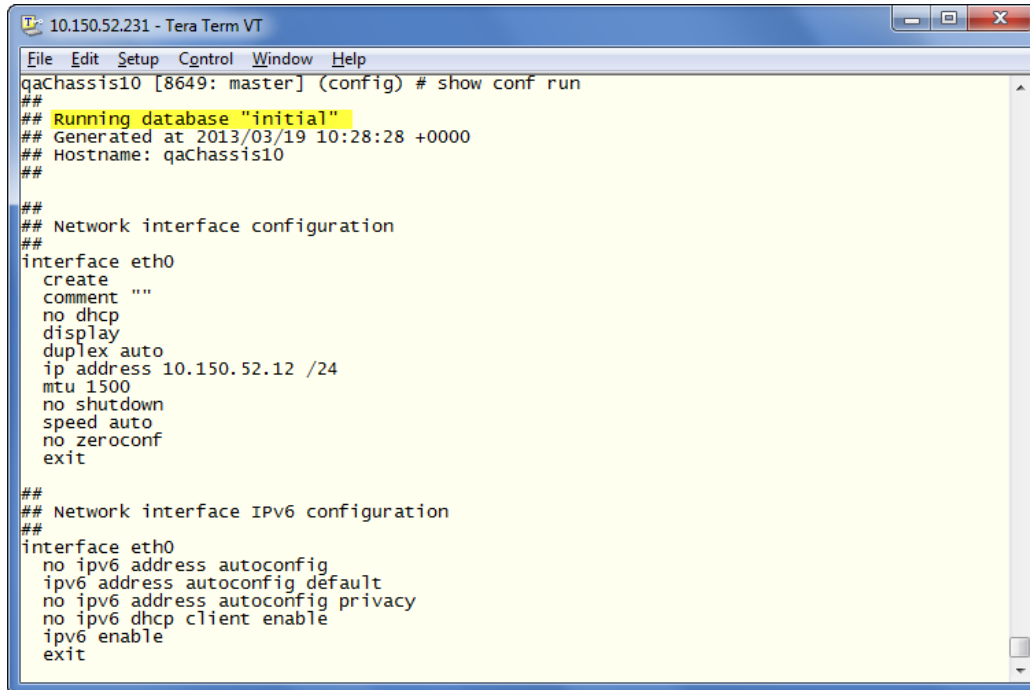

```

10.150.52.231 - Tera Term VT
File Edit Setup Control Window Help
qaChassis10 [8649: master] (config) # show conf run
##
## Running database "initial"
## Generated at 2013/03/19 10:28:28 +0000
## Hostname: qaChassis10
##
##
## Network interface configuration
##
interface eth0
  create
  comment ""
  no dhcp
  display
  duplex auto
  ip address 10.150.52.12 /24
  mtu 1500
  no shutdown
  speed auto
  no zeroconf
  exit
##
## Network interface IPv6 configuration
##
interface eth0
  no ipv6 address autoconfig
  ipv6 address autoconfig default
  no ipv6 address autoconfig privacy
  no ipv6 dhcp client enable
  ipv6 enable
  exit

```

**Figure 17** Showing the Current Configuration File

## Connecting GigaVUE-HCT Ports

This chapter describes transceivers and port connections. In general, connecting GigaVUE-HCT module ports to the network is as simple as installing a transceiver and connecting the correct cable to data sources or destinations. Refer to the following sections for details:

- [Transceiver—Rules and Notes](#)
- [Transceiver Installation Instructions](#)
- [Bypass Module Specifications](#)
- [Connecting GigaVUE-HCT Module Ports](#)

### Transceiver—Rules and Notes

Keep in mind the following rules and notes when you connect and use GigaVUE-HCT nodes with transceivers:

- Always use transceivers purchased from Gigamon to ensure interoperability and performance. Gigamon does not support transceivers purchased from other vendors.
- After removing an optical transceiver, the best practice is to wait seventeen (17) or more seconds before re-inserting the same or different optical transceiver. This includes the intervals between removal/insertion/re-insertion.
- Use the **show port params all** command to see transceiver type information for each of the network/tool ports in the GigaVUE-HCT node. Check the value of the **SFP type** field for the ports in question.
- Port numbers starting with x (for example, x10) are 10Gb or 1Gb, depending on the transceiver installed.

**NOTE:** For details about the supported transceivers, cable types, and connectivity specifications, refer to “GigaVUE-OS Compatibility and Interoperability Matrix”.

## Transceiver Installation Instructions

Gigamon transceivers are keyed and can only be installed in one direction. Transceivers are hot-swappable – they can be installed or removed with the power on or off. Use the following procedures to install and remove SFPs from GigaVUE HC Series modules.

**IMPORTANT:** Always use an ESD-preventive wrist or ankle strap and ensure that it makes good skin contact when installing or removing SFP/SFP+/SFP28 transceivers. The strap can be connected to one of the following:

- ESD wrist strap connector.
- Captive installation screws on an installed module or power supply module.
- Any unpainted surface on the chassis.

### Installing Transceivers

1. Remove the dust cap from the port and set it aside for future use.
2. Orient the transceiver with the opening in the module and insert it into the slot.
3. Push gently but firmly until the transceiver is seated in the slot.
4. Close the latch on the SFP to lock it into the slot.

### Removing Transceivers

1. Disconnect the cable (if any) from the transceiver.
2. If you are removing a fiber-optic transceiver, install dust caps in the transceiver to protect the optical interfaces.
3. Open the latch on the transceiver and gently remove it from the slot.
4. If you are not installing a new transceiver, install a dust cap in the open slot on the module.

# Copper TAP Specifications

Refer to [Table 4: Internal Transceiver Specifications for Copper TAPs](#) for specifications for copper TAPs.

Table 4: Internal Transceiver Specifications for Copper TAPs

Module Type	Transceiver Type	Speed	Auto Negotiation	Duplex
<b>TAP-HC1-G10040 Copper (RJ45)4 TAP Module</b>	N/A	10/100/1000Mb	Always ON	Full

# Bypass Module Specifications

Refer to [Table 5: Internal Transceiver Specifications for Bypass Combo Modules](#) and [Table 6: Loss Summary per Bypass Combo Modules](#) for internal transceiver specifications and loss summaries for bypass modules.

Table 5: Internal Transceiver Specifications for Bypass Combo Modules

Module Type	Transceiver Type	Speed	Auto Negotiation	Duplex
<b>BPS-HC1-D25A24 SX/SR 50/125</b>	SFP+ 1Gb/10Gb Dual Rate 850nm MM	1Gb/10Gb	Always OFF	Full
<b>BPS-HC1-D25A60 SX/SR</b>	QSFP+ 40Gb 850nm MM	1Gb/10Gb	Always OFF	Full
<b>BPS-HC1-D35C60 LX/LR</b>	QSFP+ 40Gb 1310nm SM	1Gb/10Gb	Always OFF	Full

Table 6: Loss Summary per Bypass Combo Modules

Type	@	Operating Wavelength (nm)			Cable Type	Max Fiber Length	Max Receiver Sensitivity	Insertion Loss
			Min	Typical				Max
<b>BPS-HC1-D25A24 SX/SR 50/125</b>	<b>1Gb</b>	840	850	860	LC	550m	-17	1.2
	<b>10Gb</b>	840	850	860	LC	82m	-11.1	1.2

Type	@	Operating Wavelength (nm)			Cable Type	Max Fiber Length	Max Receiver Sensitivity	Insertion Loss
			Min	Typical				Max
BPS-HC1-D25A60 SX/SR	40Gb	840	850	860	LC Multi-mode	300m	-11.1 dBm	1.2
BPS-HC1-D35C60 LX/LR	40Gb	1260	1310	1360	LC Single-mode	10km	-12.6 dBm	1.5

## Connecting GigaVUE-HCT Module Ports

Connecting network and tool ports on GigaVUE-HCT base chassis ports and modules is generally as simple as connecting a cable between the source/destination device and the GigaVUE-HCT port. You just need to make sure that the modules and ports on the GigaVUE-HCT node are enabled, and their parameters are configured correctly. Refer to the following sections for details:

- *Enabling Modules and Ports* – Make sure that the modules and ports you want to use are enabled. Newly installed modules must be configured with the **card** command and their ports enabled with **port <port-list> params admin enable**.
- *Setting Port Parameters Manually*- If both ends of the connection are using autonegotiation, no manual configuration is typically necessary. However, if autonegotiation is not used (or is not successful), you can use these instructions to configure port parameters manually.

## Enabling Modules and Ports

Use the following procedure to ensure that all modules are configured, and ports enabled:

1. Connect to the console port as described in [Access the Command-Line Interface over the Console Port](#).
2. Wait at least two minutes after the system prompt appears and then switch to **Configure** mode.

The GigaVUE-HCT node provides three command entry modes, each with increasingly powerful rights – **Standard**, **Enable**, and **Configure**. Module and port configuration commands are only available in Configure mode:

- a. Type **en <Enter>** to switch to Enable mode.

The system prompt changes from **[hostname] >** to **[hostname] #**.

- b. Type **config t <Enter>** to switch to Configure mode.

The system prompt changes from **[hostname] #** to **[hostname] (config) #**.

3. Use the following command to check module status:

**(config) # show cards**

4. Check the values in the **Config Status** and **Oper Status** columns for all modules and verify that they read **Yes** for configured and **Up** for inserted. This is your indication that the node is ready for further configuration.
5. If the **Config Status** does not show **Configured** for all modules after two minutes, take the action corresponding to your **show cards** output, as follows:

show cards Output:	Corrective Action
<b>Config Status</b> does not show <b>Configured</b> for any cards (including base chassis)	<b>(config) # chassis box-id &lt;integer&gt;(config) # card all</b>
<b>Config Status</b> shows <b>Configured</b> for base chassis but not one or more modules.	<b>(config) # card slot x</b> <div style="border: 1px solid black; padding: 5px; margin-top: 5px;"> <p><b>NOTE:</b> If all modules are unconfigured, you can also use the <b>card all</b> command. If some cards are already configured, however (for example, because you just installed a new card), it is better to use <b>slot x</b> for the unconfigured cards.</p> </div>

The **card** command initializes the unconfigured module. However, it can only be used after the node's box ID has been configured, as reported at the top of the **show cards** output (shown below).

6. Use the **show cards** command again to verify the following:

- o **Box ID** is not empty.
- o **Config Status** shows **configured** for all modules.
- o **Oper Status** shows **up** for all modules.

The **show cards** command output for a GigaVUE-HCT displays the properly configured modules.

```
HCT (config) # sh card
```

```
Box ID: 5
```

Slot	Config	Oper Status	HW Type	Product Code	Serial Num	HW Rev
cc1	yes	up	HCT-Main-Board-HW	132-00HA	1HA0-0040	1.3-0f
1	yes	up	HCT-C02-HW	132-00HM	1HM0-0040	1.3-f
2	yes	up	TAP-HC1-G10040-HW	132-00D8	1D80-0016	2.0-22

- Use the **port** command with the **admin** argument to enable the ports on the module. For example, the following two commands enable all ports on a PRT-HC1-Q04X08 module:

```
(config) # port 1/2/x1..x8 params admin enable
```

- Save your changes so that the modules and ports come up automatically at the next reboot:

```
(config) # write memory
```

## Setting Port Parameters Manually

If autonegotiation is not enabled on the other end of the connection, you must manually configure the **port params** of the GigaVUE-HCT module port to match, followed by a **write** to save the current settings.

The **port params** commands are available in the Configure mode. The syntax is as follows:

```
port <port-list> params      admin <disable | enable>      autoneg <disable |
enable>      discovery <cdp | lldp | all | disable>      duplex
<full>      forcelinkup <disable | enable>      speed <10 | 100 | 1000 |
10000>      taptx <active | passive>
```

The following table summarizes these options:

Argument	Description
<b>admin</b> <disable   enable>	Enables/disables ports administratively. Use the <b>show port params</b> command to see which ports are enabled and disabled. Refer to <a href="#">Setting Port Parameters Manually</a> for a summary of how this argument interacts with the <b>admin</b> argument.
<b>autoneg</b> <disable   enable>	Enables and disables autonegotiation for a port. When autonegotiation is enabled, duplex and speed settings are ignored (they are set via autonegotiation). Refer to <a href="#">Setting Port Parameters Manually</a> for a summary of how this argument interacts with the <b>admin</b> argument. Autonegotiation is always disabled for 10Gb ports. For 1Gb speeds over copper, autonegotiation must be enabled, per the IEEE 802.3 specification. Gb optical ports cannot enable autoneg.

Argument	Description
<b>discovery</b> <b>&lt;cdp   lldp   all   disable&gt;</b>	Configures port discovery options, as follows: cpd—Enables CDP port discovery. lldp—Enables LLDP port discovery. all—Enables all port discovery protocols (meaning both CDP and LLDP). disable—Disables port discovery. Discovery is disabled by default. To enable discovery, configure one or more protocols.
<b>duplex &lt;full&gt;</b>	Specifies the port's duplex configuration. Only full duplex is supported. Starting in software version 5.2, half duplex support is removed from all GigaVUE HC Series nodes. If half duplex was configured in a previous software version, it will remain intact following the upgrade to 5.2 or higher release. Update to full duplex, if required.
<b>forcelinkup</b> <b>&lt;disable   enable&gt;</b>	Forces connection on an optical port. Use this option when an optical tool port is connected to a legacy optical tool that does not transmit light. Available as follows: Optical 1Gb/10Gb/25Gb tool ports Not available for 10Gb-capable ports with a 1Gb SFP installed. 10Gb-capable optical tool ports only support <b>forcelinkup</b> when a 10Gb SFP+ is installed.

## Forcelinkup and Enabling/Disabling Ports

The GigaVUE-HCT node includes both **forcelinkup** and **admin** arguments for the **port params** command. The **forcelinkup** argument forces the link state on an optical tool port connected to a legacy tool that does not transmit the light required to bring the link up. The following table summarizes how traffic flows for different combinations of **port params admin** and **port params forcelinkup** applied to an optical tool port.

	<b>forcelinkup = disable</b>	<b>forcelinkup = enable</b>
<b>admin = enable</b>	No traffic passed if autonegotiation is not successful.	Traffic is passed.
<b>admin = disable</b>	No traffic passed.	No traffic passed.

# GigaVUE-HCT Specifications

This appendix provides the physical specifications, power requirements, and environmental specifications for GigaVUE-HCT nodes. Compliance with safety, emissions, and immunity is also provided.

Refer to the following sections for details:

- [Physical Dimensions and Weight](#)



- [Battery Caution](#)
- [Compliance](#)
- [Power Requirements](#)
- [Environmental Specifications](#)
- [Standards and Protocols](#)
- [Warranty](#)

## Physical Dimensions and Weight

The following table summarizes the dimensions and weight of the GigaVUE-HCT nodes and their modules:

Node	Height	Width	Depth	Weight
GigaVUE-HCT	1 RU 1.75in (4.45cm)	Metal to Metal 8.40in (21.34cm)	Metal to Metal 12.5 inch (31.75cm)	5.8lb (2.65kg)
BPS-HC1-D25A24 Bypass Combo Module	1.6in (4.10cm)	4.65in (11.80cm)	10.13in(24.98cm)	2.2lb (0.99kg)
BPS-HC1-D25A60 BypassModule	1.6in (4.06cm)	4.65in (11.80cm)	10.13in(24.98cm)	2.2lb (0.99kg)
BPS-HC1-D35C60 Bypass Module	1.6in (4.10cm)	4.65in (11.80cm)	10.13in(24.98cm)	2.2lb (0.99kg)
PRT-HC1-X12 Module	1.6in (4.10cm)	4.65in (11.80cm)	10.13in(24.98cm)	1.55lb (0.70kg)
PRT-HC1-Q04x08 Module	1.6in (4.10cm)	4.65in (11.80cm)	10.13in(24.98cm)	1.4lb (0.68kg)
SMT-HC1-S Module	1.6in (4.10cm)	4.65in (11.80cm)	10.13in (24.98cm)	2.54lb (1.15kg)
TAP-HC1-G10040 Copper (RJ-45)4 TAP Module	1.6in (4.10cm)	4.65in (11.80cm)	10.13in(24.98cm)	1.5lb(0.68kg)

## Battery Caution

A disposable, non-rechargeable, Real Time Clock (RTC) Lithium metal coin cell battery is in the GigaVUE-HCT. Note the following:

- There is a risk of fire if the battery is replaced with an incorrect type.
- Use only CR-2032L type Lithium metal coin cell battery and replace with the same.

## Compliance

This section provides compliance information for GigaVUE-HCT.

## Safety

GigaVUE-HCT is compliant with the following safety regulations:

- UL623681-1/CSA C22.2 No. 62368-1

## Emissions

GigaVUE-HCT is compliant with the following emissions regulations:

- FCC Part 15, Class A
- EU:CE Mark EN 55022, EN 55035. Class A
- UKCA

## Immunity

GigaVUE-HCT is compliant with the following immunity regulations:

- ETSI EN 300 386 V1.3.2
- EN61000-4-2
- EN61000-4-3
- EN61000-4-4
- EN61000-4-5
- EN61000-4-6
- EN61000-3-2

## Environmental

GigaVUE-HCT is compliant with the following environmental regulations:

- RoHS 6: EU directive 2002/95/EU

## Security

- Common Criteria (Certification pending). Refer to “Common Criteria” in the **GigaVUE-OS CLI Reference Guide**.
- FIPS 140-2. Refer to “FIPS 140-2 Compliance” in the **GigaVUE-OS CLI Reference Guide**.

## Power Requirements

The following table summarizes the electrical characteristics of GigaVUE-HCT nodes.

**NOTE:** Refer to [Connecting Power to the GigaVUE-HCT](#) for instructions on how to connect AC power supply modules.

Power Specification	Specification
Power Configuration	1 + 1 Power: 2 Power Adapters
Max Power Consumption/Heat	190 Watts / 648 BTU/hr Fully populated system with all ports at 100% traffic load

Power Specification	Specification
Output	
AC Power Adapters	Input Voltage: 90 – 264V AC, Input Frequency: 47 – 63 Hz Input Current: 3A@ 115V AC, 1.5A@230 V AC

## Environmental Specifications

The following table summarizes the environmental specifications for GigaVUE-HCT nodes.

Specification	GigaVUE-HCT Node
Operating Temperature	32°F to 104°F (0°C to 40°C)
Operating Relative Humidity	20% to 80%, non-condensing
Recommended Storage Temperature	-4°F to 158°F (-20°C to 70°C)
Recommended Storage Relative Humidity	15% to 85%, non-condensing
Altitude	Up to 10,000ft (3.05km)

## Standards and Protocols

IEEE 802.3-2012, IEEE 802.1Q VLAN, IEEE 802.3 10BASE-T, IEEE 802.3u 100BASE-TX, IEEE 802.3ab 1000BASE-T, IEEE 802.3z 1000BASE-X, IEEE 802.3ae 10000BASE-X, IEEE 802.3ba, RFC 783 TFTP, RFC 791 IP, RFC 793, TCP, RFC 826 ARP, RFC 768 UDP, RFC 792 ICMP, SNMP v2c/v3, RFC 2131 DHCP client, RFC 1492 TACACS+, and support for IPv4 and IPv6.

## Warranty

Gigamon offers a range of premium support and extended services. For details regarding warranty, visit: <https://www.gigamon.com/support-and-services/warranty>

# Console Port Signaling and Cabling

This appendix provides the pin-outs for the RJ45-to-RJ45 rollover cable and RJ45-to-DB-9 adapter provided with the GigaVUE-HCT node for connections from the node's console port to a PC's COM port.

The following figure shows how to connect the RJ45-to-RJ45 rollover cable from the GigaVUE-HCT node's console port to a COM port on a PC using the RJ45-to-DB-9 adapter.

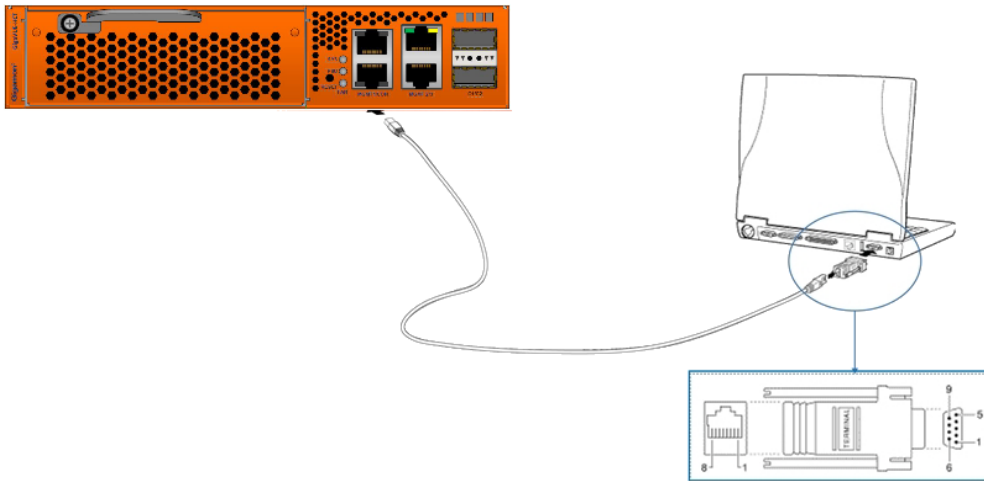

The following table lists the pinouts for this connection.

Console Port from GigaVUE-HCT RJ45 Jack	RJ45-to-RJ45 Rollover Cable		RJ45-to-DB-9 Terminal Adapter	Console Device on PC
Signal	RJ45 Pin	RJ45 Pin	DB-9 Pin	Signal
N/A	1	8	8	N/A
N/A	2	7	6	N/A
TxD	3	6	2	RxD
GND	4	5	5	GND
GND	5	4	5	GND
RxD	6	3	3	TxD
N/A	7	2	4	N/A
N/A	8	1	7	N/A

# Additional Sources of Information

This appendix provides additional sources of information. Refer to the following sections for details:

- [Documentation](#)
- [Documentation Feedback](#)
- [Contact Technical Support](#)
- [Contact Sales](#)
- [The VÜE Community](#)

## Documentation

This table lists all the guides provided for GigaVUE HC Series software and hardware. The first row provides an All-Documents Zip file that contains all the guides in the set for the release.

**NOTE:** In the online documentation, view [What's New](#) to access quick links to topics for each of the new features in this Release; view [Documentation Downloads](#) to download all PDFs.

Table 1: Documentation Set for Gigamon Products

GigaVUE HC Series 6.9 Hardware and Software Guides
<b>DID YOU KNOW?</b> If you keep all PDFs for a release in common folder, you can easily search across the doc set by opening one of the files in Acrobat and choosing <b>Edit &gt; Advanced Search</b> from the menu. This opens an interface that allows you to select a directory and search across all PDFs in a folder.
<b>Hardware</b> how to unpack, assemble, rackmount, connect, and initially configure ports the respective GigaVUE HC Series devices; reference information and specifications for the respective GigaVUE HC Series devices
<b>GigaVUE-HC1 Hardware Installation Guide</b>
<b>GigaVUE-HC3 Hardware Installation Guide</b>
<b>GigaVUE-HC1-Plus Hardware Installation Guide</b>
<b>GigaVUE-HCT Hardware Installation Guide</b>
<b>GigaVUE-TA25 Hardware Installation Guide</b>
<b>GigaVUE-TA25E Hardware Installation Guide</b>
<b>GigaVUE-TA100 Hardware Installation Guide</b>

## GigaVUE HC Series 6.9 Hardware and Software Guides

**GigaVUE-TA200 Hardware Installation Guide**

**GigaVUE-TA200E Hardware Installation Guide**

**GigaVUE-TA400 Hardware Installation Guide**

**GigaVUE-OS Installation Guide for DELL S4112F-ON**

**G-TAP A Series 2 Installation Guide**

**GigaVUE M Series Hardware Installation Guide**

**GigaVUE-FM Hardware Appliances Guide**

### Software Installation and Upgrade Guides

**GigaVUE-FM Installation, Migration, and Upgrade Guide**

**GigaVUE-OS Upgrade Guide**

**GigaVUE V Series Migration Guide**

### Fabric Management and Administration Guides

**GigaVUE Administration Guide**

covers both GigaVUE-OS and GigaVUE-FM

**GigaVUE Fabric Management Guide**

how to install, deploy, and operate GigaVUE-FM; how to configure GigaSMART operations; covers both GigaVUE-FM and GigaVUE-OS features

### Cloud Guides

how to configure the GigaVUE Cloud Suite components and set up traffic monitoring sessions for the cloud platforms

**GigaVUE V Series Applications Guide**

**GigaVUE V Series Quick Start Guide**

**GigaVUE Cloud Suite Deployment Guide - AWS**

**GigaVUE Cloud Suite Deployment Guide - Azure**

**GigaVUE Cloud Suite Deployment Guide - OpenStack**

**GigaVUE Cloud Suite Deployment Guide - Nutanix**

**GigaVUE Cloud Suite Deployment Guide - VMware (ESXi)**

**GigaVUE Cloud Suite Deployment Guide - VMware (NSX-T)**

**GigaVUE Cloud Suite Deployment Guide - Third Party Orchestration**

**Universal Cloud TAP - Container Deployment Guide**

## GigaVUE HC Series 6.9 Hardware and Software Guides

### Gigamon Containerized Broker Deployment Guide

### GigaVUE Cloud Suite Deployment Guide - AWS Secret Regions

### GigaVUE Cloud Suite Deployment Guide - Azure Secret Regions

## Reference Guides

### GigaVUE-OS CLI Reference Guide

library of GigaVUE-OS CLI (Command Line Interface) commands used to configure and operate GigaVUE HC Series and GigaVUE TA Series devices

### GigaVUE-OS Security Hardening Guide

### GigaVUE Firewall and Security Guide

### GigaVUE Licensing Guide

### GigaVUE-OS Cabling Quick Reference Guide

guidelines for the different types of cables used to connect Gigamon devices

### GigaVUE-OS Compatibility and Interoperability Matrix

compatibility information and interoperability requirements for Gigamon devices

### GigaVUE-FM REST API Reference in GigaVUE-FM User's Guide

samples uses of the GigaVUE-FM Application Program Interfaces (APIs)

### Factory Reset Guidelines for GigaVUE-FM and GigaVUE-OS Devices

Sanitization guidelines for GigaVUE Fabric Management Guide and GigaVUE-OS devices.

## Release Notes

### GigaVUE-OS, GigaVUE-FM, GigaVUE-VM, G-TAP A Series, and GigaVUE Cloud Suite Release Notes

new features, resolved issues, and known issues in this release ;  
important notes regarding installing and upgrading to this release

**NOTE:** Release Notes are not included in the online documentation.

**NOTE:** Registered Customers can log in to [My Gigamon](#) to download the Software and Release Notes from the Software and Docs page on to [My Gigamon](#). Refer to [How to Download Software and Release Notes from My Gigamon](#).

## In-Product Help

### GigaVUE-FM Online Help

how to install, deploy, and operate GigaVUE-FM.

## How to Download Software and Release Notes from My Gigamon

Registered Customers can download software and corresponding Release Notes documents from the **Software & Release Notes** page on to [My Gigamon](#). Use the My Gigamon Software & Docs page to download:

- Gigamon Software installation and upgrade images,
- Release Notes for Gigamon Software, or
- Older versions of PDFs (pre-v5.7).

### To download release-specific software, release notes, or older PDFs:

1. Log in to [My Gigamon](#).
2. Click on the **Software & Release Notes** link.
3. Use the **Product** and **Release** filters to find documentation for the current release. For example, select Product: "GigaVUE-FM" and Release: "5.6," enter "pdf" in the search box, and then click **GO** to view all PDF documentation for GigaVUE-FM 5.6.xx.

**NOTE:** My Gigamon is available to registered customers only. Newer documentation PDFs, with the exception of release notes, are all available through the publicly available online documentation.

## Documentation Feedback

We are continuously improving our documentation to make it more accessible while maintaining accuracy and ease of use. Your feedback helps us to improve. To provide feedback and report issues in our documentation, send an email to:

[documentationfeedback@gigamon.com](mailto:documentationfeedback@gigamon.com)

Please provide the following information in the email to help us identify and resolve the issue. Copy and paste this form into your email, complete it as able, and send. We will respond as soon as possible.

Documentation Feedback Form		
About You	Your Name	
	Your Role	
	Your Company	



<b>For Online Topics</b>	<b>Online doc link</b>	<i>(URL for where the issue is)</i>
	<b>Topic Heading</b>	<i>(if it's a long topic, please provide the heading of the section where the issue is)</i>
<b>For PDF Topics</b>	<b>Document Title</b>	<i>(shown on the cover page or in page header )</i>
	<b>Product Version</b>	<i>(shown on the cover page)</i>
	<b>Document Version</b>	<i>(shown on the cover page)</i>
	<b>Chapter Heading</b>	<i>(shown in footer)</i>
	<b>PDF page #</b>	<i>(shown in footer)</i>
<b>How can we improve?</b>	<b>Describe the issue</b>	<i>Describe the error or issue in the documentation. (If it helps, attach an image to show the issue.)</i>
	<b>How can we improve the content?</b> <b>Be as specific as possible.</b>	
	<b>Any other comments?</b>	

## Contact Technical Support

For information about Technical Support: Go to **Settings**  **> Support > Contact Support** in GigaVUE-FM.

You can also refer to <https://www.gigamon.com/support-and-services/contact-support> for Technical Support hours and contact information.

Email Technical Support at [support@gigamon.com](mailto:support@gigamon.com).

# Contact Sales

Use the following information to Gigamon channel partner or Gigamon sales representatives.

**Telephone:** +1.408.831.4025

**Sales:** [inside.sales@gigamon.com](mailto:inside.sales@gigamon.com)

**Partners:** [www.gigamon.com/partners.html](http://www.gigamon.com/partners.html)

# Premium Support

Email Gigamon at [inside.sales@gigamon.com](mailto:inside.sales@gigamon.com) for information on purchasing 24x7 Premium Support. Premium Support entitles you to round-the-clock phone support with a dedicated Support Engineer every day of the week.

# The VÜE Community

The [VÜE Community](#) is a technical site where Gigamon users, partners, security and network professionals and Gigamon employees come together to share knowledge and expertise, ask questions, build their network and learn about best practices for Gigamon products.

Visit the VÜE Community site to:

- Find knowledge base articles and documentation
- Ask and answer questions and learn best practices from other members.
- Join special-interest groups to have focused collaboration around a technology, use-case, vertical market or beta release
- Take online learning lessons and tutorials to broaden your knowledge of Gigamon products.
- Open support tickets (Customers only)
- Download the latest product updates and documentation (Customers only)

The VÜE Community is a great way to get answers fast, learn from experts and collaborate directly with other members around your areas of interest.

**Register today at** [community.gigamon.com](http://community.gigamon.com)

**Questions?** Contact our Community team at [community@gigamon.com](mailto:community@gigamon.com).